

# Smart Healthcare - Cybersecurity Perspectives

Keynote – Cybersecurity and Cloud Computing  
Workshop 2023

21 Mar 2023

Grambling State University

Saraju Mohanty

University of North Texas, USA.

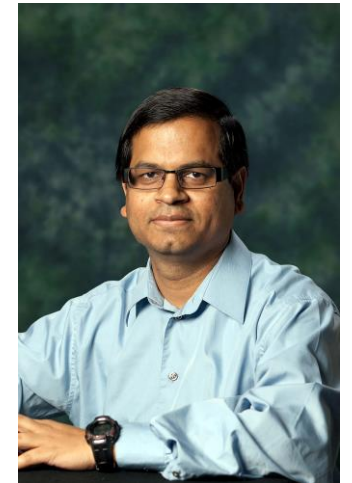

Website



---

# Outline

- Smart Healthcare – Introduction
- Smart Healthcare – Challenges
- Selected Cybersecurity Solutions for IoT/CPS
- Drawbacks of Existing Cybersecurity Solutions
- Security by Design (SbD) Principle
- Security by Design (SbD) Example Solutions
- Trustworthy Pharmaceutical Supply Chain
- Is PUF the Solution of Every Cybersecurity Problems?
- Is Blockchain the Solution of Every Cybersecurity Problems?
- Conclusions and Future Directions

---

# Smart Healthcare – Introduction

# Human Body and Health

## Human Body

- From an engineering perspective - Human body can be defined as a combination of multi-disciplinary subsystems (electrical, mechanical, chemical ...).

## Health

- Human health is a state of complete physical, mental and social well-being.

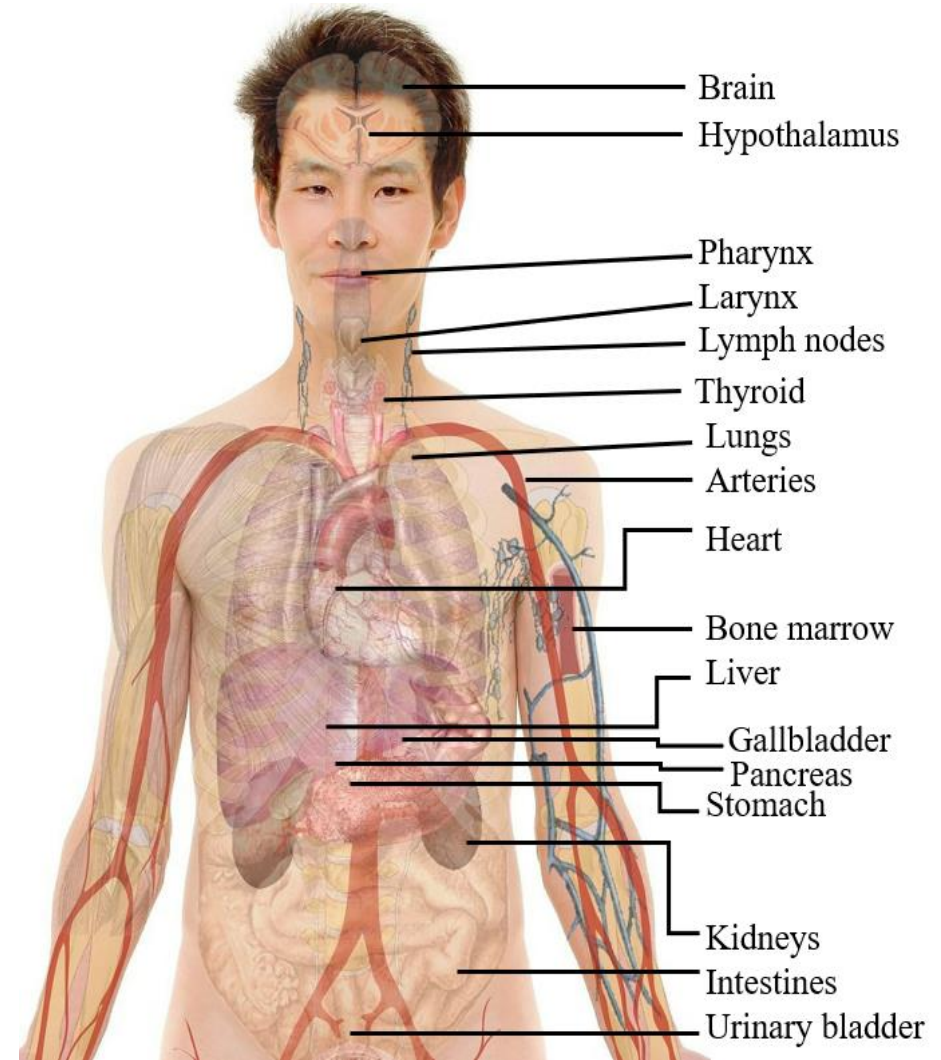



# Traditional Healthcare

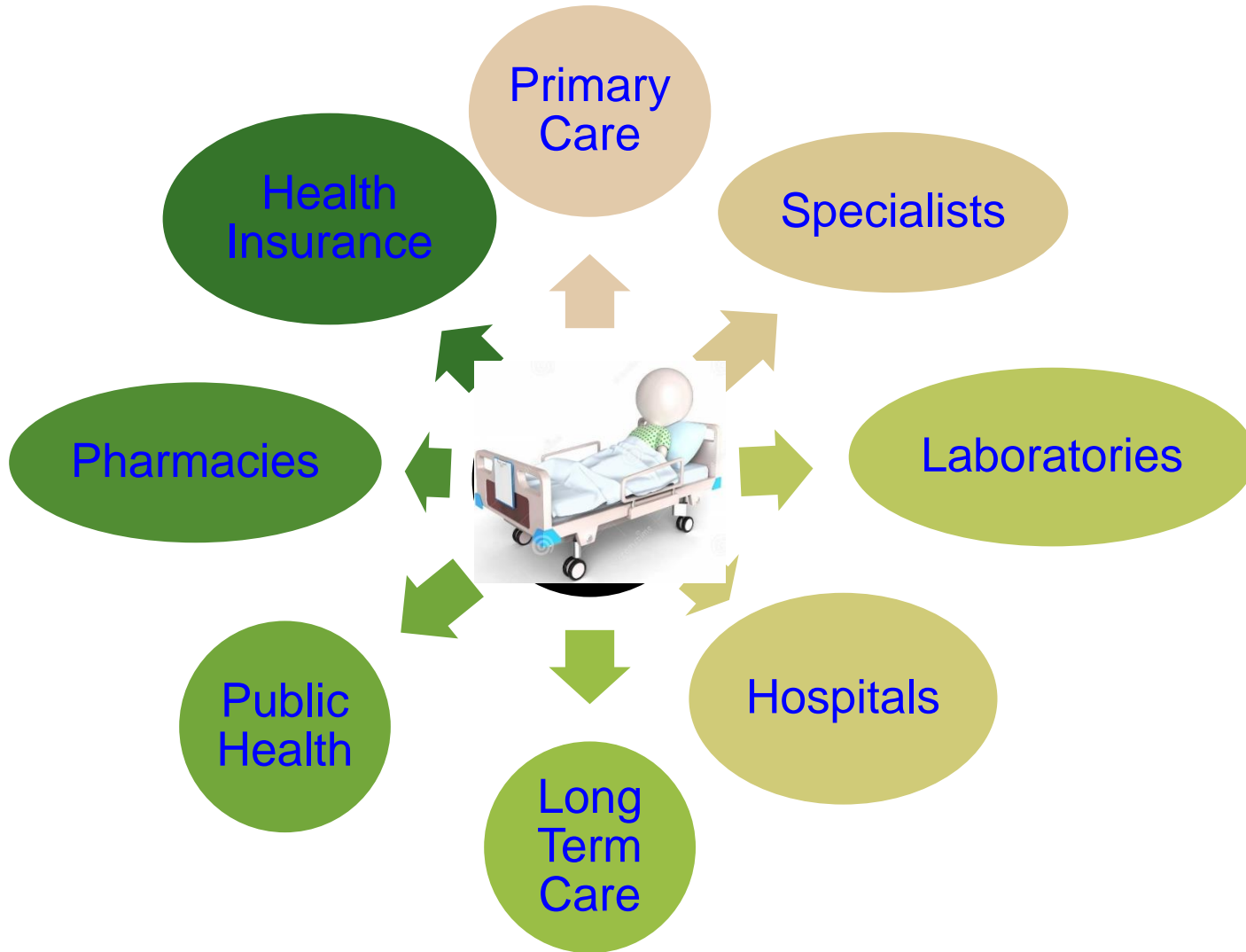

- Physical presence needed
- Deals with many stakeholders
- Stakeholders may not interact
- May not be personalized
- Not much active feedback
- Less effective follow-up from physicians

# Healthcare → Smart Healthcare

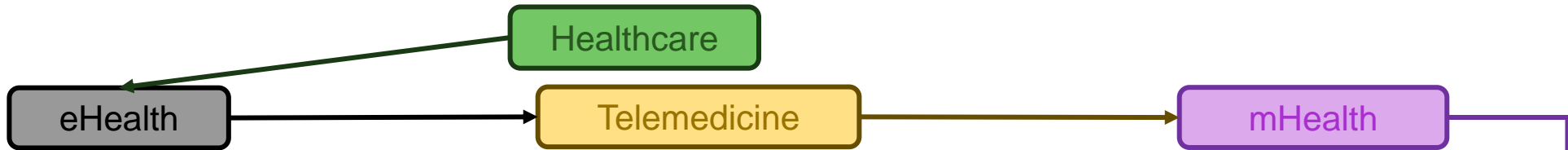

The use of information and communication technologies (ICT) to improve healthcare services.

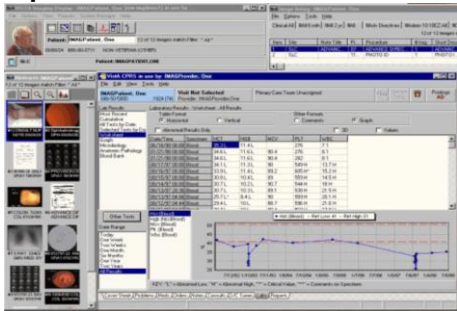

Telemedicine is the use of telecommunication and information technology to provide clinical healthcare from a distance.

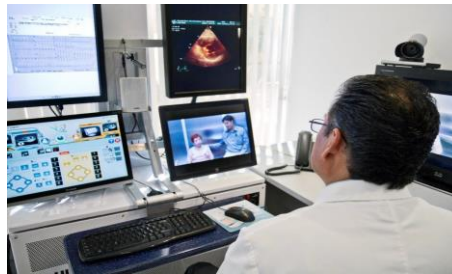

Healthcare supported by *mobile devices* that uses mobile telecommunications and multimedia technologies for the delivery of healthcare services and health information.



Embedded Skin Patches

Thync's - UltrasonoVibeund

Muse - EEG

sHealth

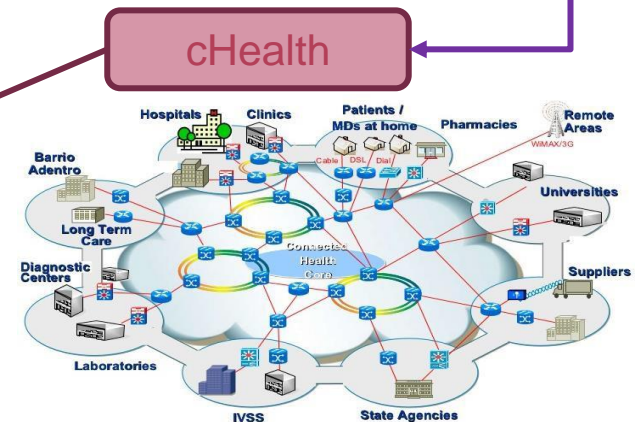

Source: **S. P. Mohanty**, "Smart Healthcare: From Healthcare to Smart Healthcare", ICCE 2020 Panel, Jan 2020.

# Smart Healthcare (sHealth)

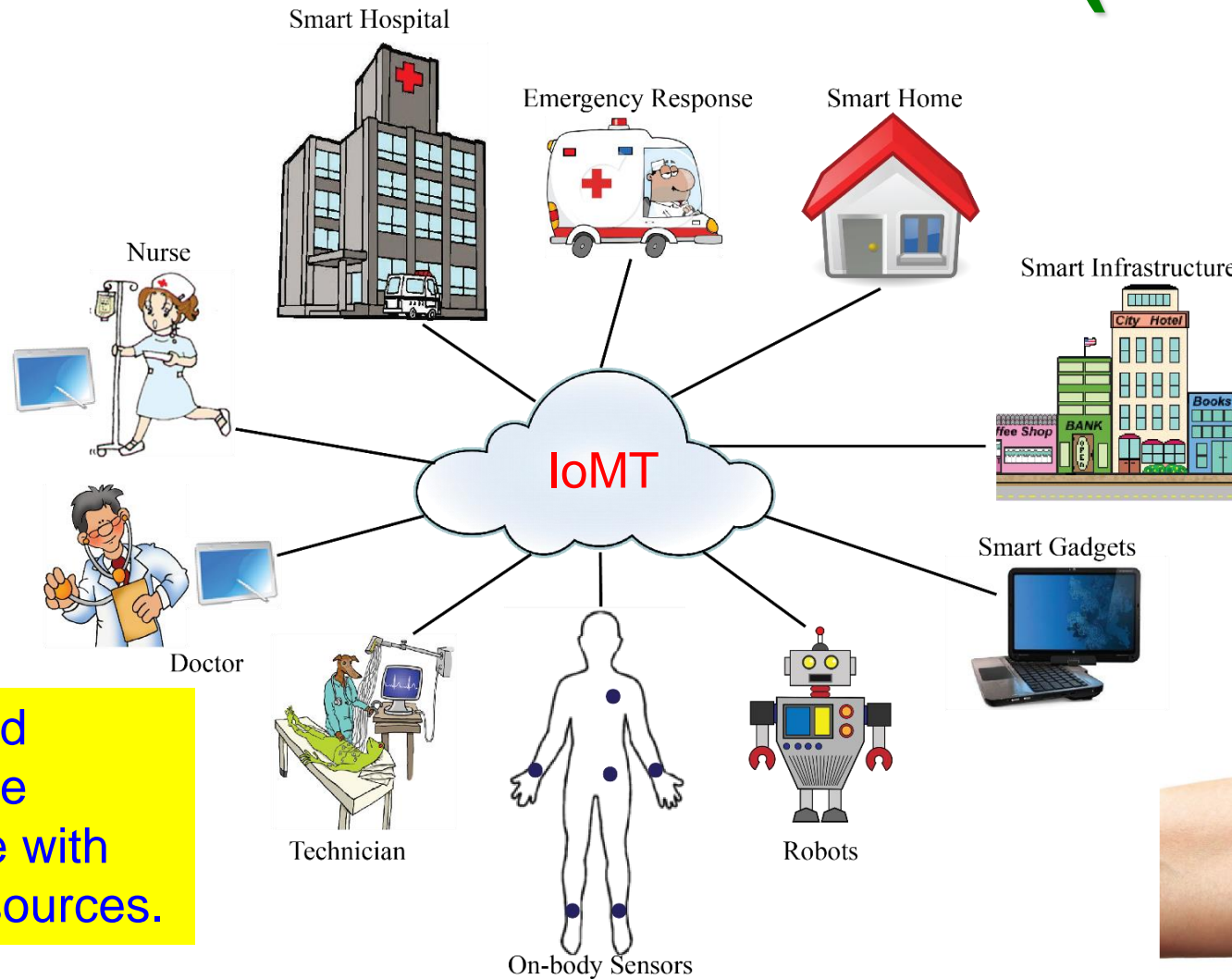

Fitness Trackers



Headband with Embedded Neurosensors

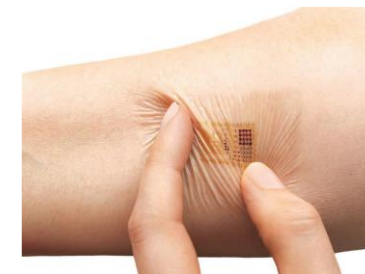

Embedded Skin Patches

Quality and sustainable healthcare with limited resources.

Source: P. Sundaravadivel, E. Kougianos, S. P. Mohanty, and M. Ganapathiraju, "Everything You Wanted to Know about Smart Health Care", *IEEE Consumer Electronics Magazine (MCE)*, Vol. 7, Issue 1, January 2018, pp. 18-28.

# What is Smart Healthcare?

Smart Healthcare ←  
Conventional Healthcare  
+ Body sensors  
+ Smart Technologies  
+ Information & Communication Technology (ICT)  
+ AI/ML

Internet of Medical Things (IoMT)

Internet of Health Things (IoHT)

Healthcare Cyber-Physical Systems (H-CPS)

Source: P. Sundaravadivel, E. Kougianos, S. P. Mohanty, and M. Ganapathiraju, "Everything You Wanted to Know about Smart Health Care", *IEEE Consumer Electronics Magazine (MCE)*, Volume 7, Issue 1, January 2018, pp. 18-28.



# Smart Healthcare – Healthcare CPS

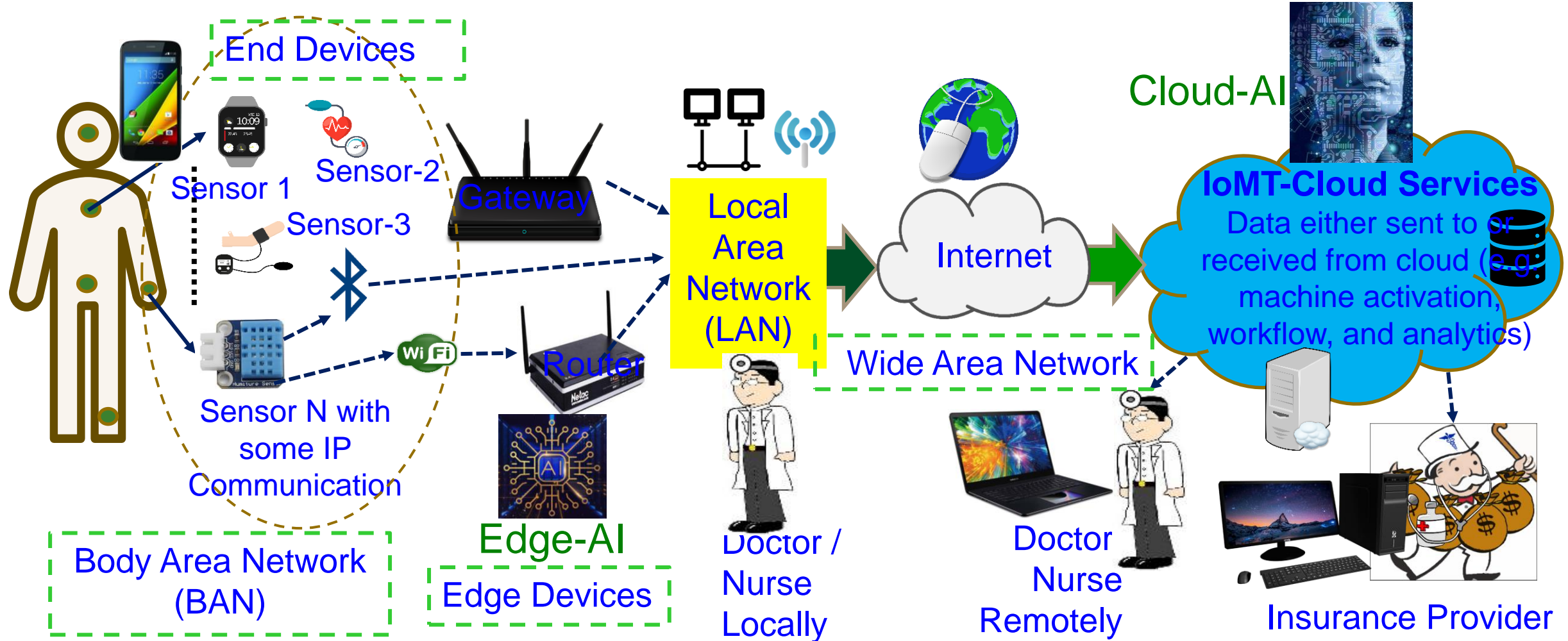

Frost and Sullivan predicts smart healthcare market value to reach US\$348.5 billion by 2025.

Source: S. P. Mohanty, Secure IoT by Design, Keynote, 4th IFIP International Internet of Things Conference (IFIP-IoT), 2021, Amsterdam, Netherlands, 5th November 2021.

---

# Smart Healthcare – Some Challenges

# IoT/CPS – Selected Challenges

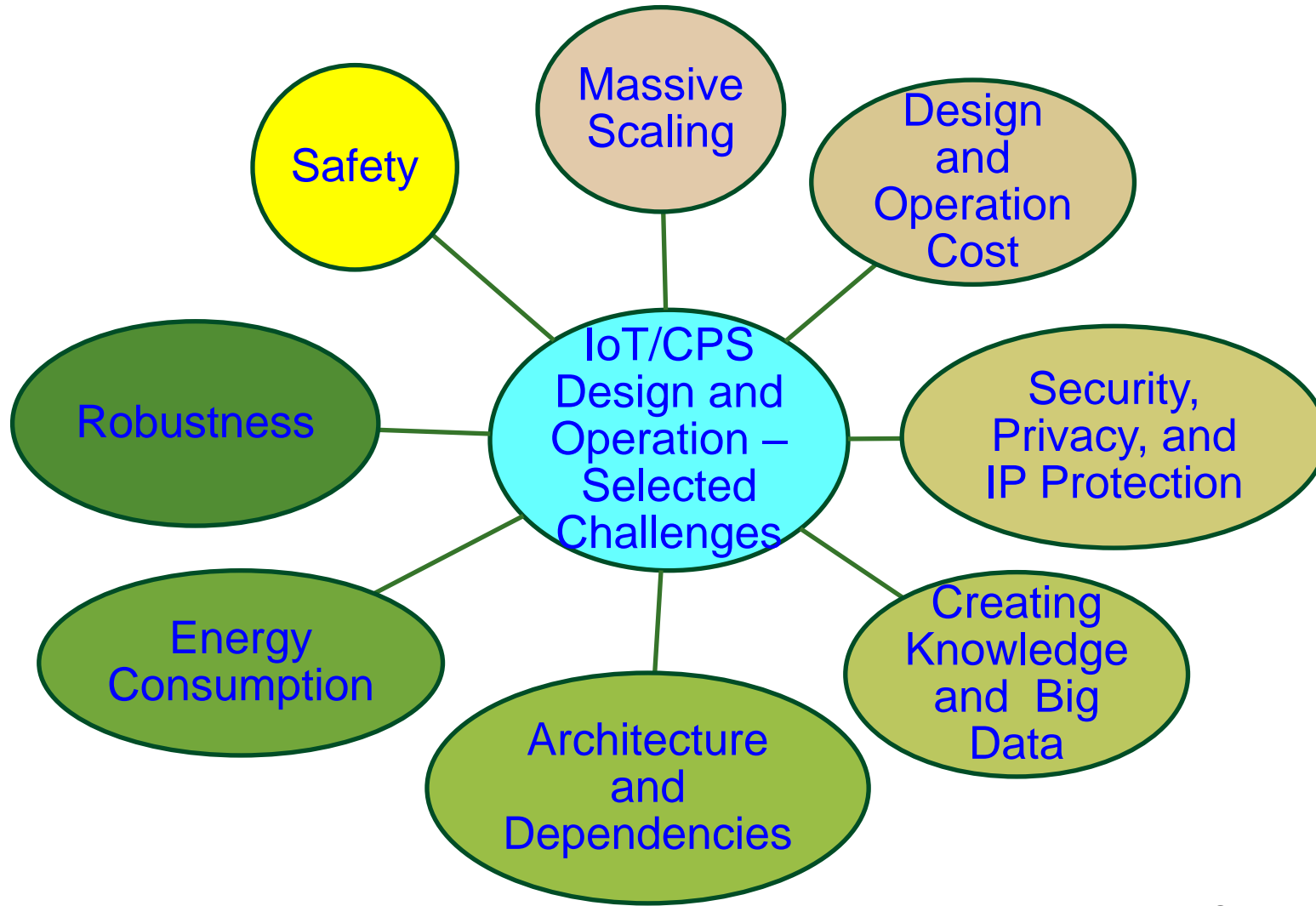

Source: Mohanty ICIT 2017 Keynote



# Massive Growth of Sensors/Things

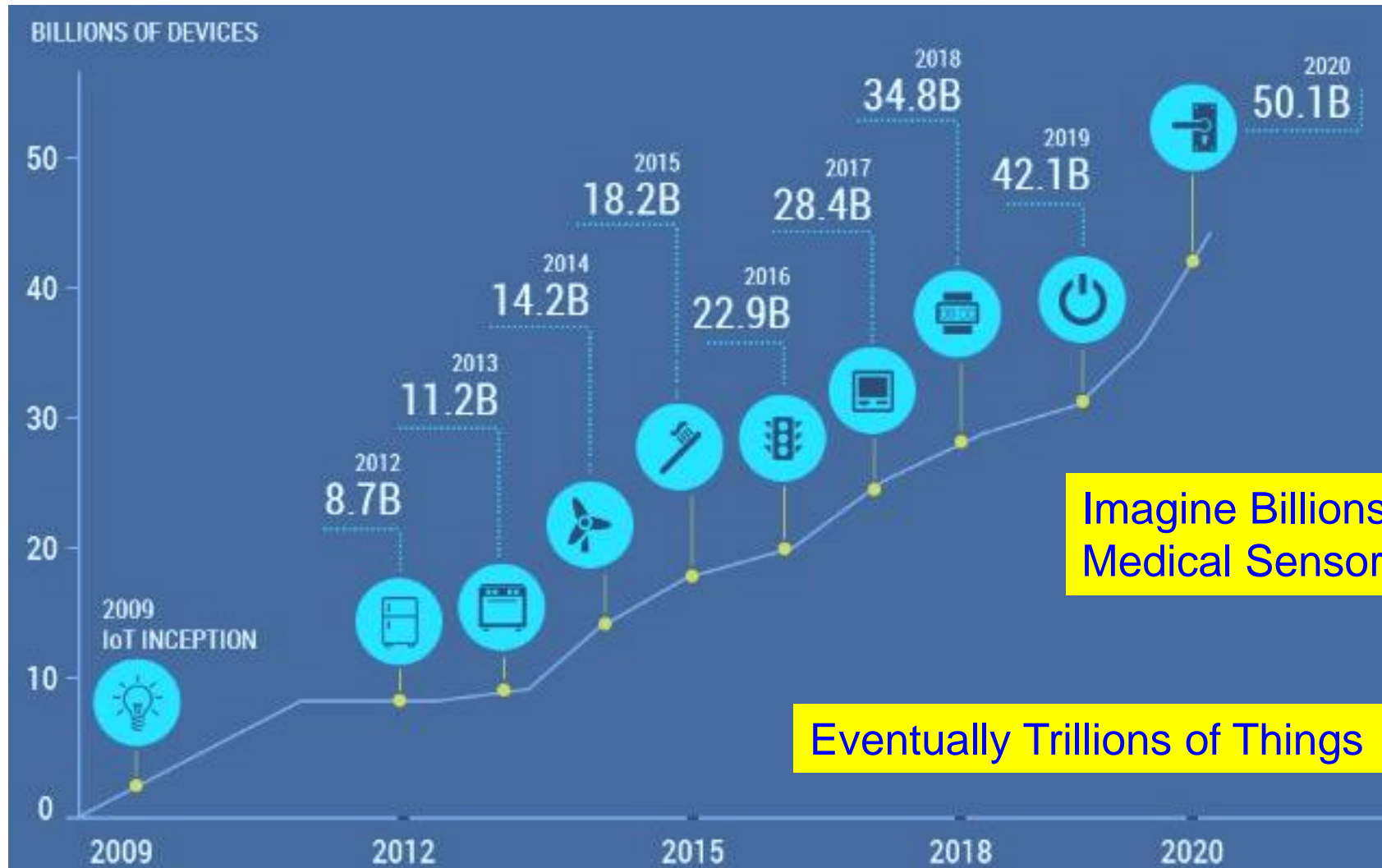

Imagine Billions of user with Medical Sensors!

Eventually Trillions of Things

Source: <https://www.linkedin.com/pulse/history-iot-industrial-internet-sensors-data-lakes-0-downtime>

# Challenges of Data in IoT/CPS are Multifold



# AI/ML Modeling Challenges



## Machine Learning Issues

High Energy Requirements

High Computational Resource Requirements

Large Amount of Data Requirements

Underfitting and Overfitting Issue

Class Imbalance Issue

Fake Data Issue

Attack on Training Process

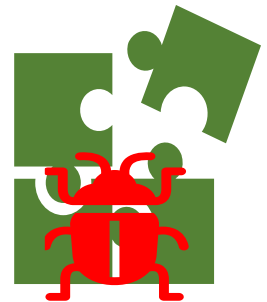
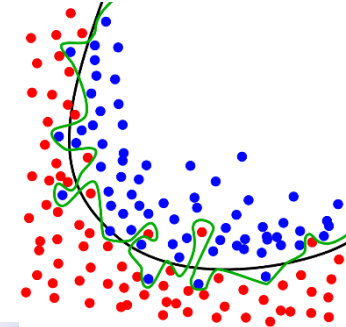

Source: Mohanty ISCT Keynote 2019

# Deep Neural Network (DNN) - Resource and Energy Costs

**TRAIN:** Iterate until you achieve satisfactory performance.

Needs Significant:

- Computational Resource
- Computation Energy

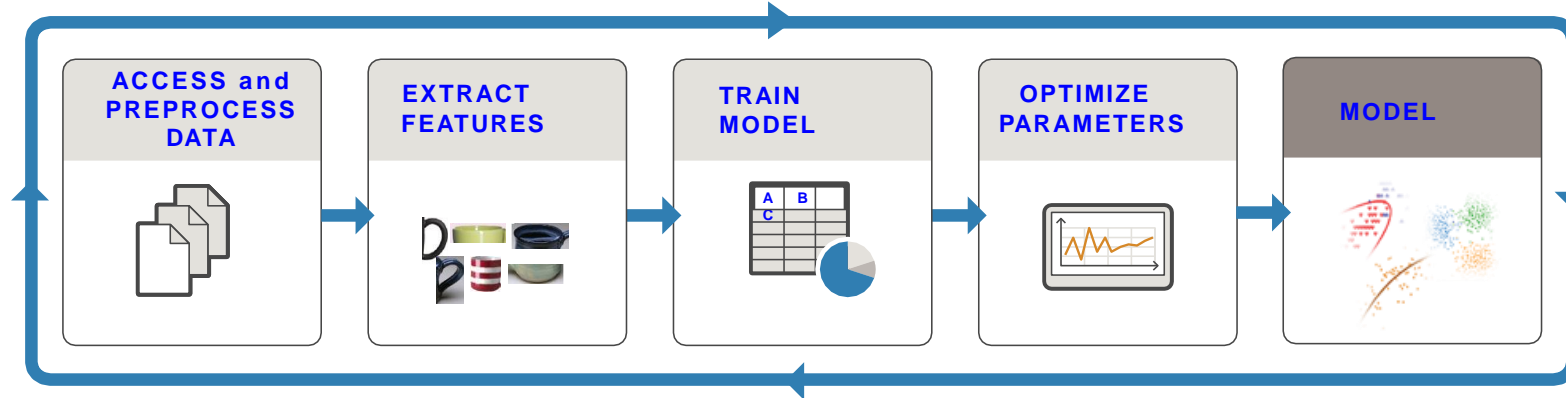

**PREDICT:** Integrate trained models into applications.

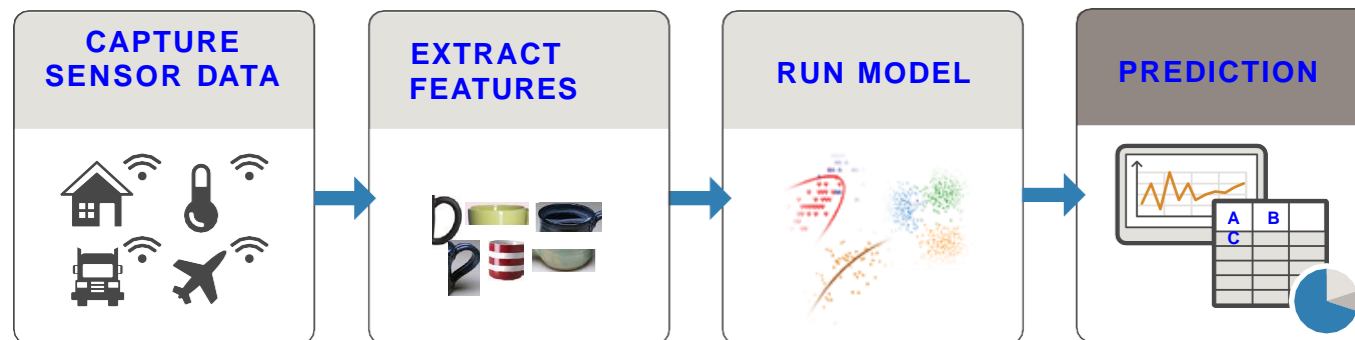

Needs:

- Computational Resource
- Computation Energy



Source: <https://www.mathworks.com/campaigns/offers/mastering-machine-learning-with-matlab.html>

# AI/ML – Cybersecurity Issue

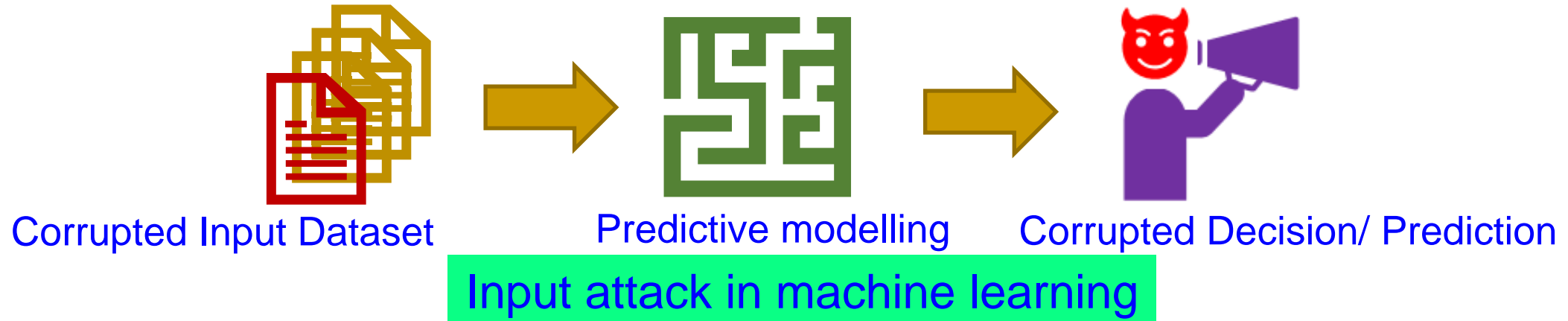

Source: D. Puthal, and S. P. Mohanty, "Cybersecurity Issues in AI", *IEEE Consumer Electronics Magazine (MCE)*, Vol. 10, No. 4, July 2021, pp. 33--35.



# Wrong ML Model → Wrong Diagnosis

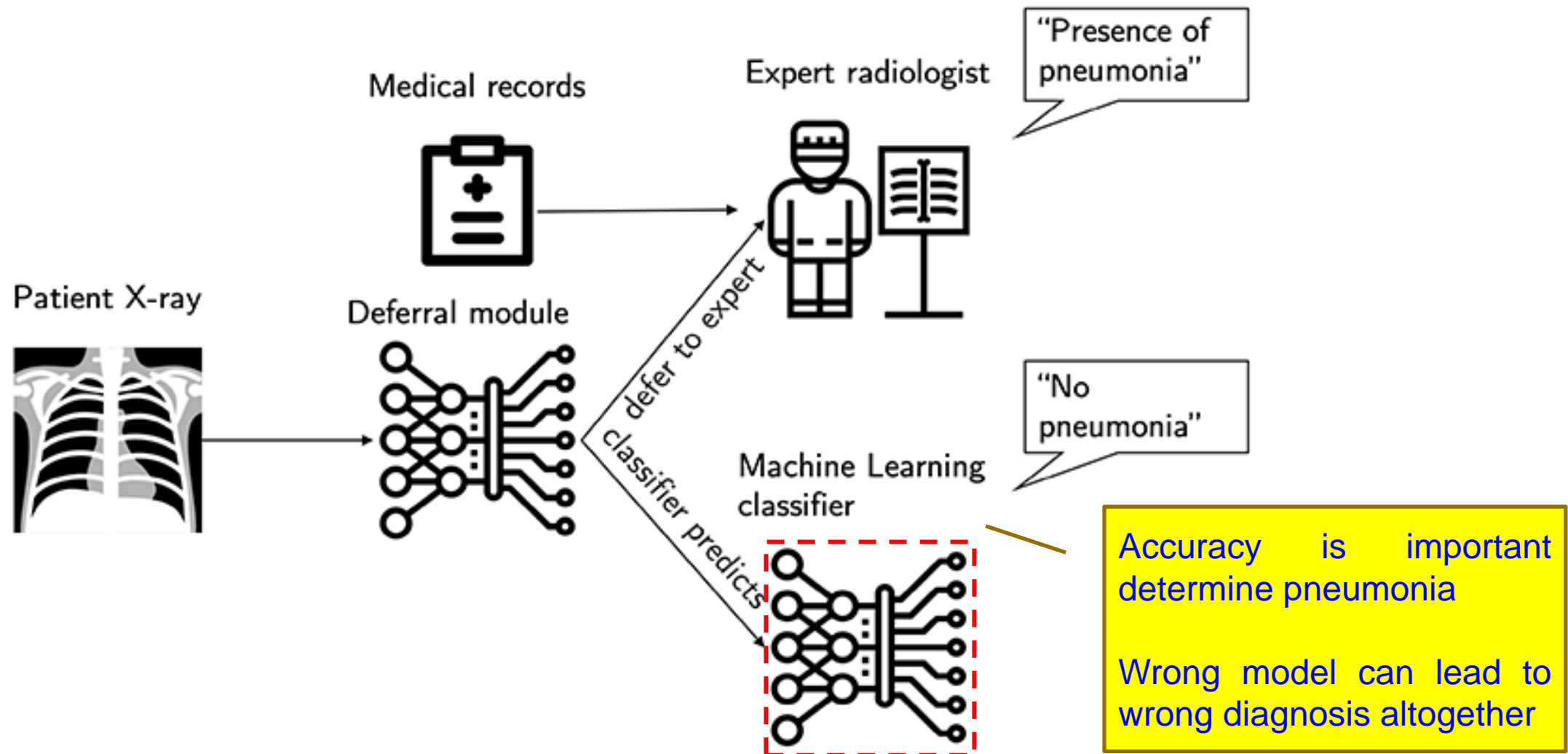

Source: <https://www.healthcareitnews.com/news/new-ai-diagnostic-tool-knows-when-defer-human-mit-researchers-say>

# Smart Healthcare - Security Challenges



Selected Smart Healthcare Security/Privacy Challenges

Data Eavesdropping

Data Confidentiality

Data Privacy

Data Integrity

Identity Threats

Unique Identification

Personal Privacy

Location Privacy

Access Control

Device Security

Source: P. Sundaravadivel, E. Kougianos, S. P. Mohanty, and M. Ganapathiraju, "Everything You Wanted to Know about Smart Health Care", *IEEE Consumer Electronics Magazine (CEM)*, Volume 7, Issue 1, January 2018, pp. 18-28.



---

# IoMT/H-CPS Security Issue is Real and Scary

- Insulin pumps are vulnerable to hacking, FDA warns amid recall:

<https://www.washingtonpost.com/health/2019/06/28/insulin-pumps-are-vulnerable-hacking-fda-warns-amid-recall/>

- Software vulnerabilities in some medical devices could leave them susceptible to hackers, FDA warns:

<https://www.cnn.com/2019/10/02/health/fda-medical-devices-hackers-trnd/index.html>

- FDA Issues Recall For Medtronic mHealth Devices Over Hacking Concerns:

<https://mhealthintelligence.com/news/fda-issues-recall-for-medtronic-mhealth-devices-over-hacking-concerns>

# Fake Data and Fake Hardware – Both are Equally Dangerous in CPS



AI can be fooled by fake data



AI can create fake data (Deepfake)

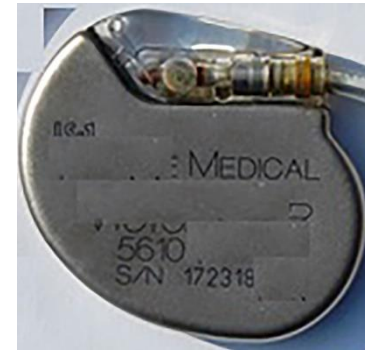

Authentic

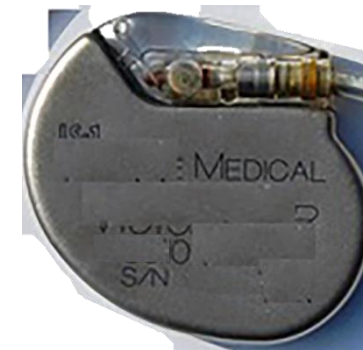

Fake

An implantable medical device



Authentic

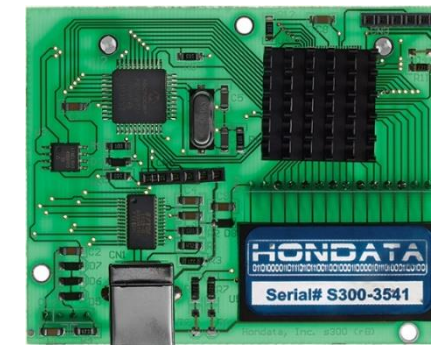

Fake

A plug-in for car-engine computers



# Fake is Cheap – Why not Buy?



Is my Pacemaker Authentic or Fake?

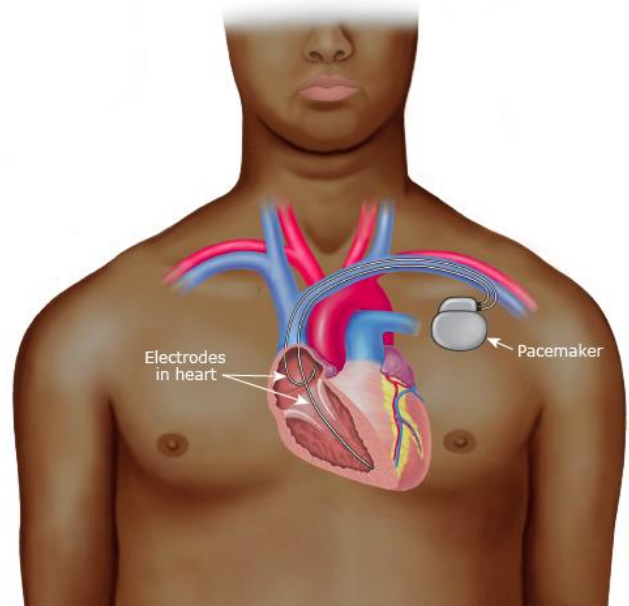

International Pharmaceutical Students' Federation  
Asia Pacific Regional Office

## THE NEGATIVE IMPACTS OF FAKE MEDICINE

- Increased mortality and morbidity
- Development of drug resistance
- Increase the chance of adverse effects
- Loss of confidence in health systems and health workers
- Undermining of drug research and development
- Crowding out of legitimate drug manufacturers
- Decreased willingness of patients to accept treatment
- Economic loss for patients and health systems

Source: <https://apro.ipsof.org/>

# Health Insurance Portability and Accountability Act (HIPAA)

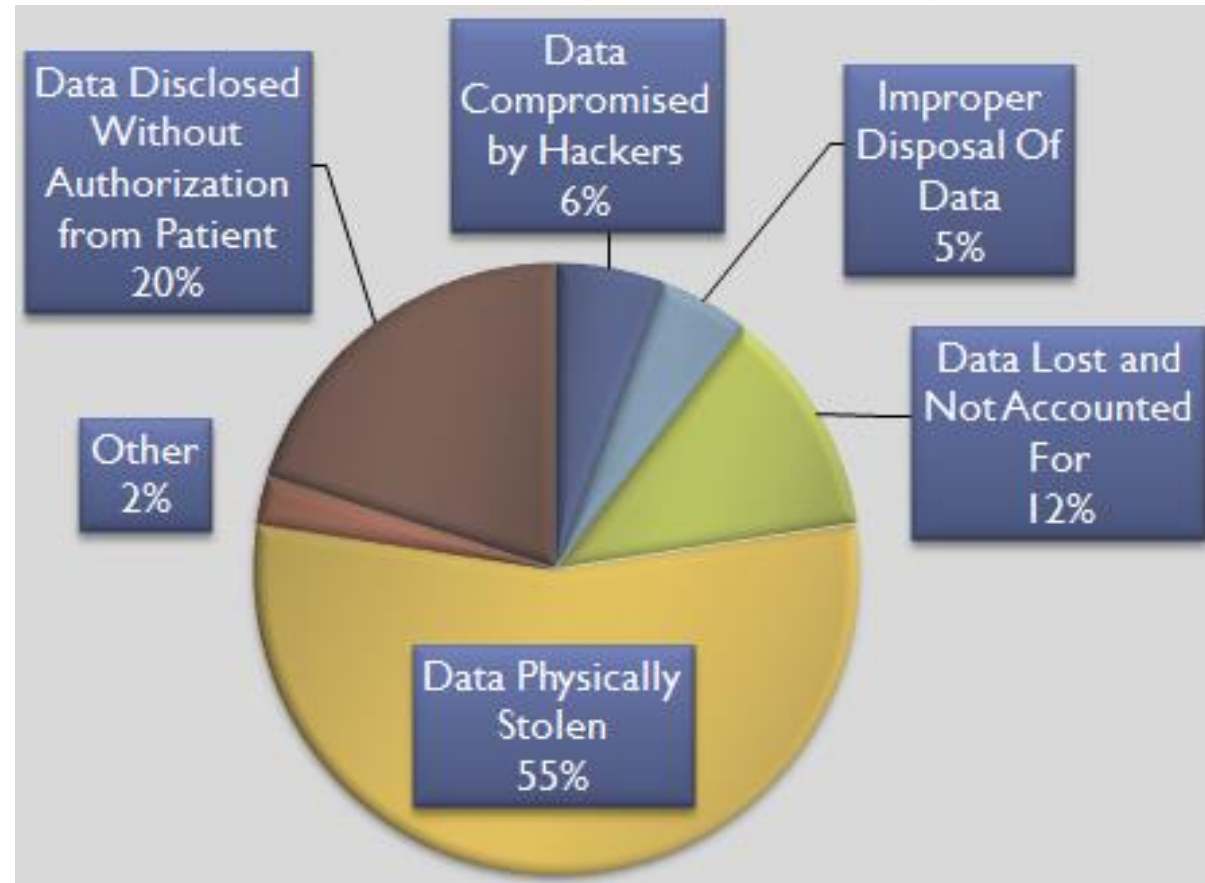

HIPPA Privacy Violation by Types

---

# Cybrsecurity Solution for IoT/CPS





# IoT Cybersecurity - Attacks and Countermeasures

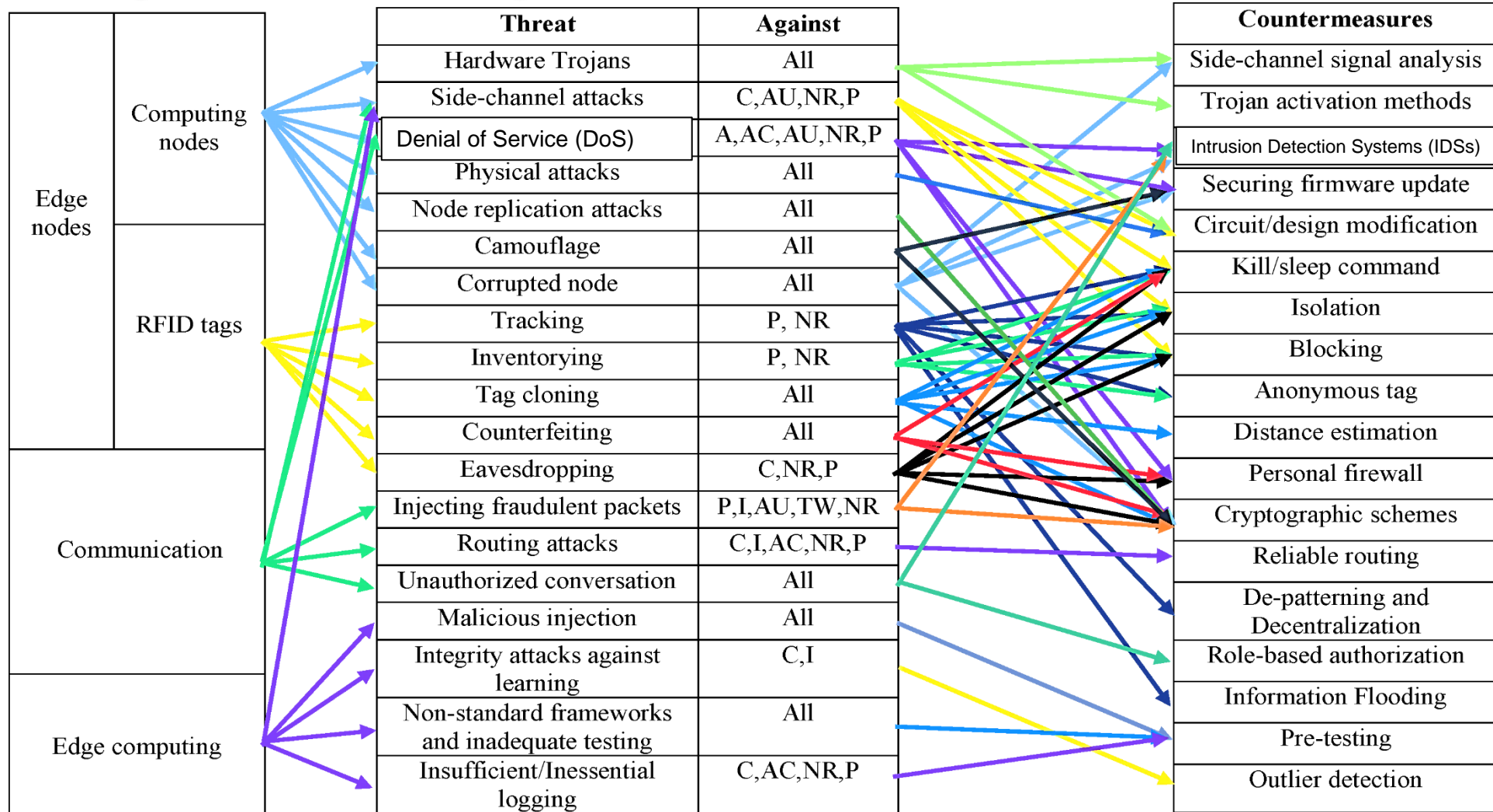

C- Confidentiality, I – Integrity, A - Availability, AC – Accountability, AU – Auditability, TW – Trustworthiness, NR - Non-repudiation, P - Privacy

Source: A. Mosenia, and Niraj K. Jha. "A Comprehensive Study of Security of Internet-of-Things", *IEEE Transactions on Emerging Topics in Computing*, 5(4), 2016, pp. 586-602.

# Our Swing-Pay - NFC Cybersecurity Solution

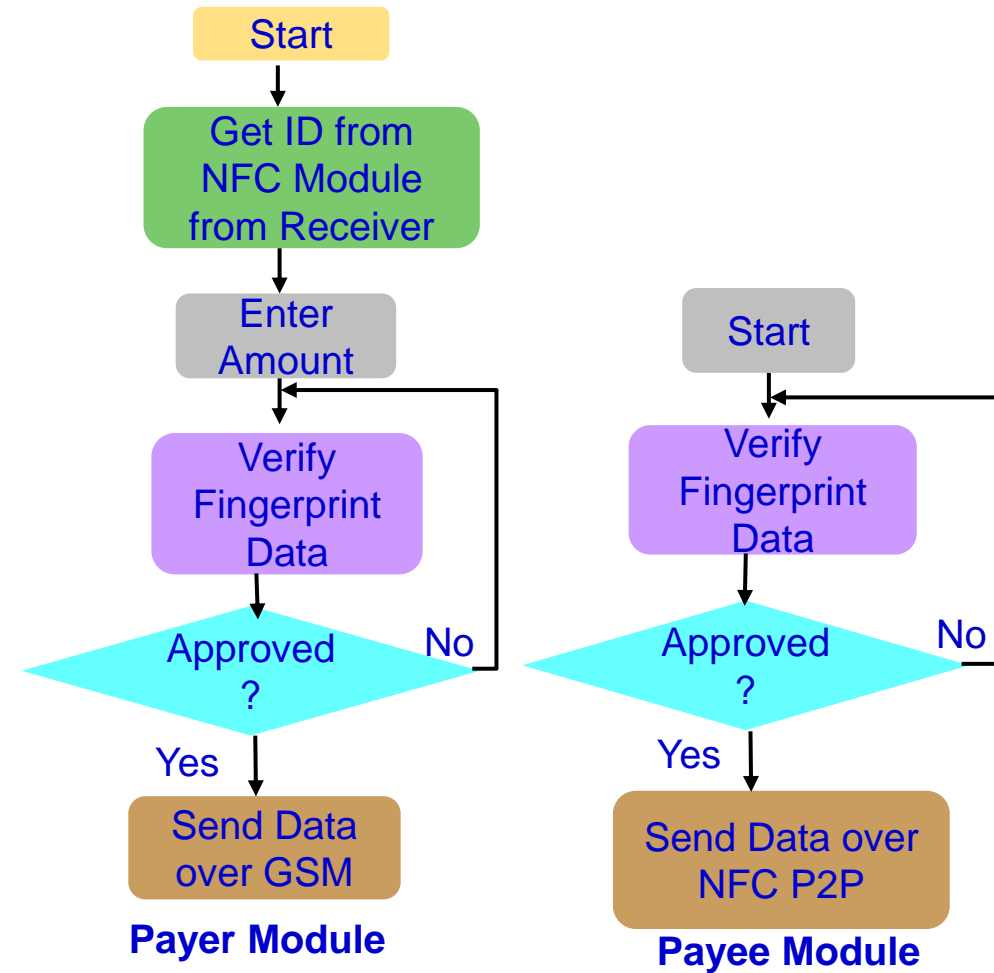
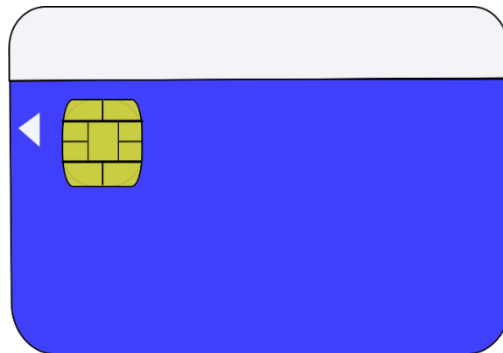
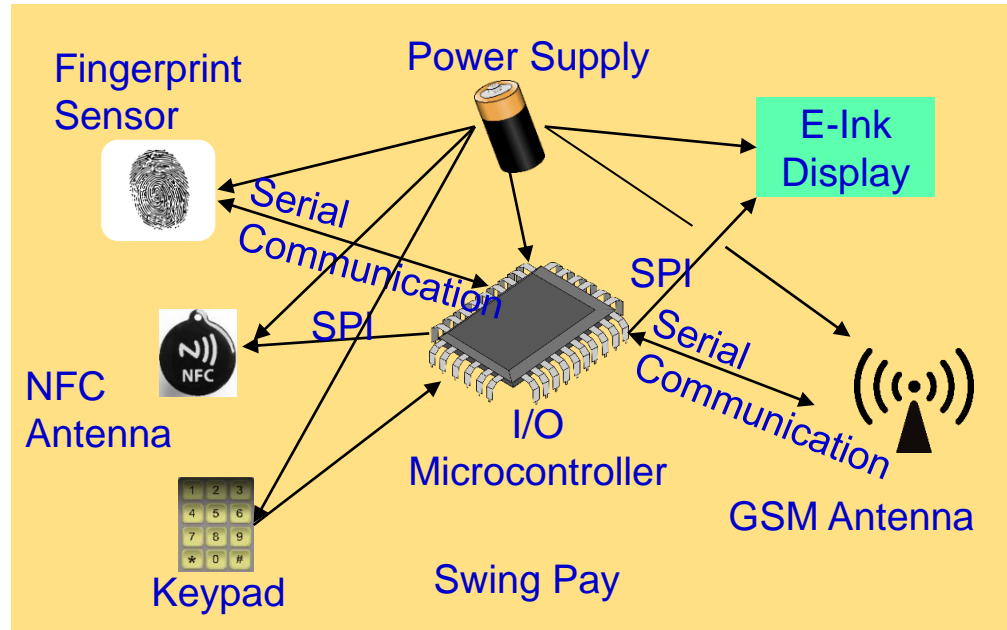

Source: S. Ghosh, J. Goswami, A. Majumder, A. Kumar, **S. P. Mohanty**, and B. K. Bhattacharyya, "Swing-Pay: One Card Meets All User Payment and Identity Needs", *IEEE Consumer Electronics Magazine (MCE)*, Volume 6, Issue 1, January 2017, pp. 82--93.



# RFID Cybersecurity - Solutions

## Selected RFID Security Methods



Faraday Cage

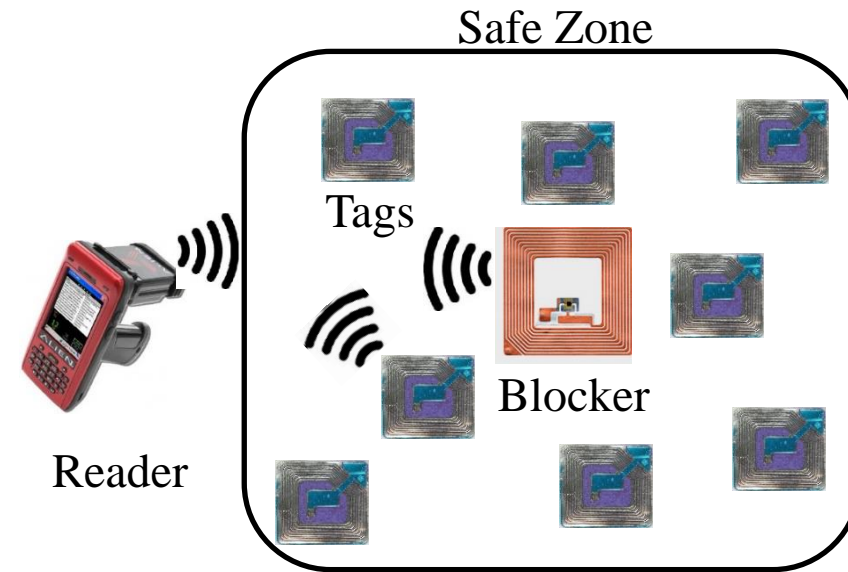
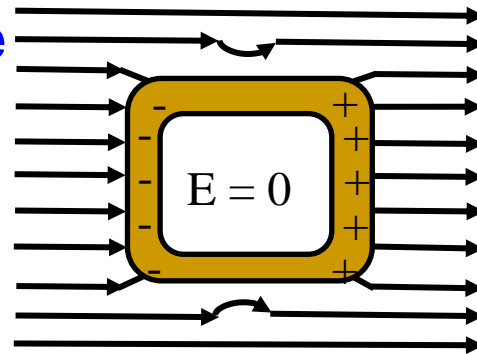

Blocker Tags

Source: Khattab 2017, Springer 2017 RFID Security

# Firmware Cybersecurity - Solution

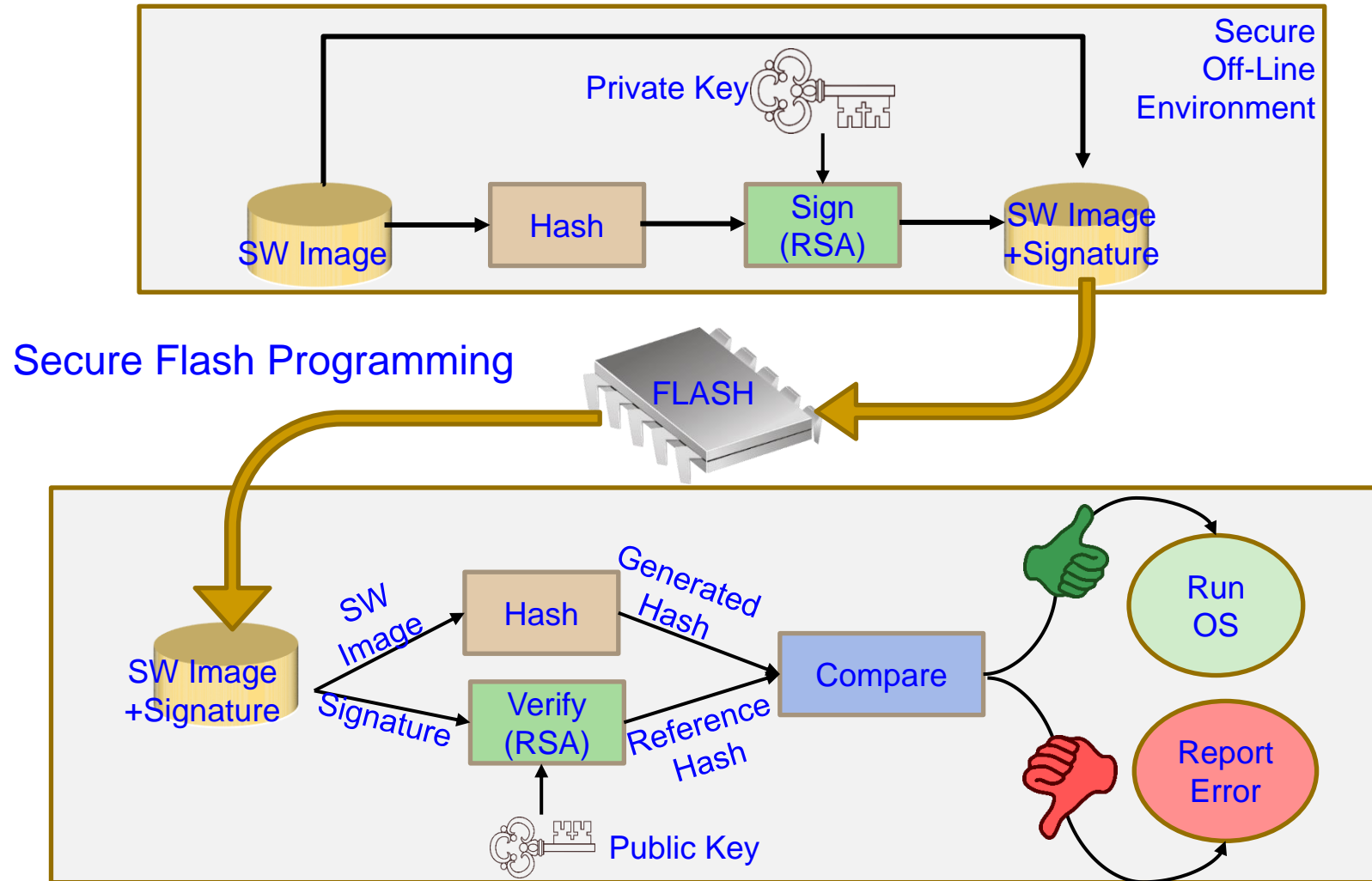

Source: <https://www.nxp.com/docs/en/white-paper/AUTOSECURITYWP.pdf>

# Nonvolatile Memory Security and Protection



Source: <http://datalocker.com>

Nonvolatile / Harddrive Storage

Hardware-based encryption of data secured/protected by strong password/PIN authentication.

Software-based encryption to secure systems and partitions of hard drive.

Some performance penalty due to increase in latency!

How Cloud storage changes this scenario?

# Embedded Memory Security

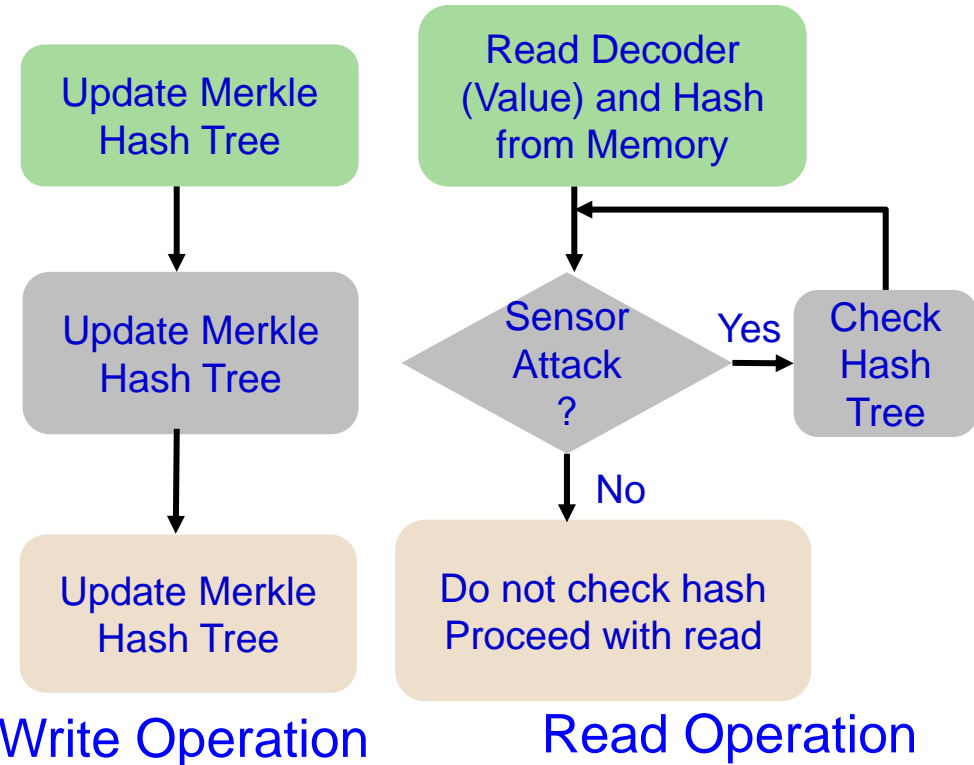
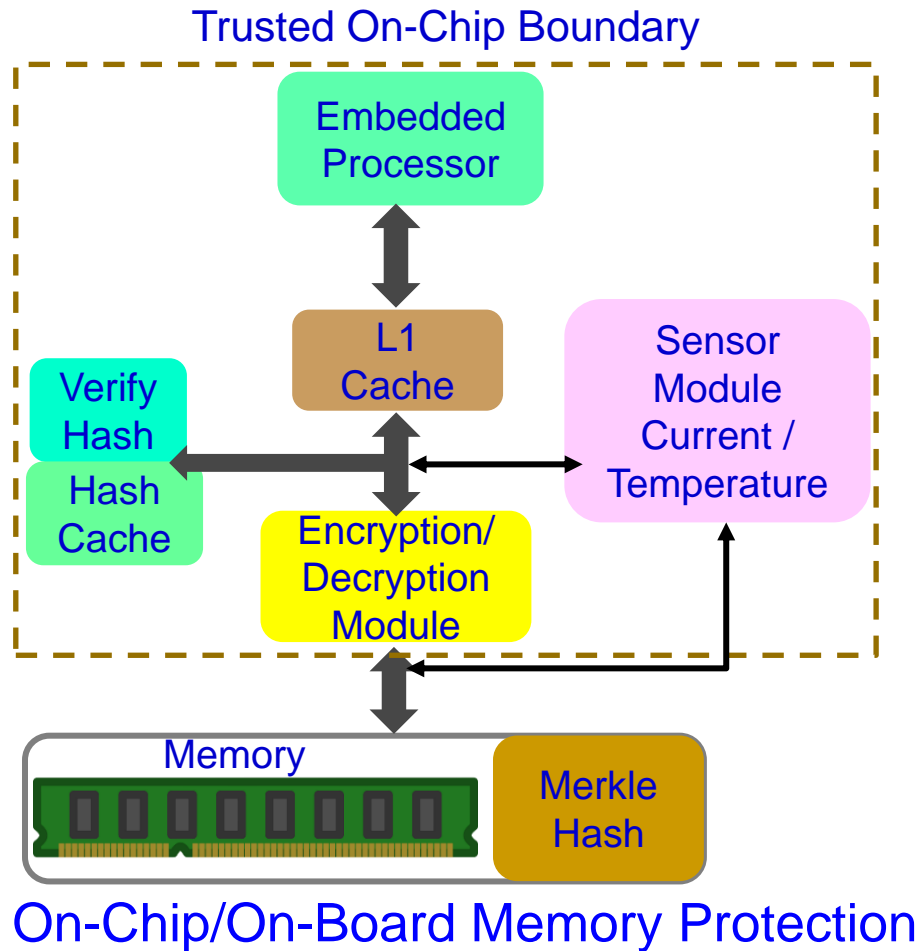

Memory integrity verification with 85% energy savings with minimal performance overhead.

Source: S. Nimgaonkar, M. Gomathisankaran, and S. P. Mohanty, "MEM-DnP: A Novel Energy Efficient Approach for Memory Integrity Detection and Protection in Embedded Systems", *Springer Circuits, Systems, and Signal Processing Journal (CSSP)*, Volume 32, Issue 6, December 2013, pp. 2581--2604.

# Smart Healthcare Cybersecurity

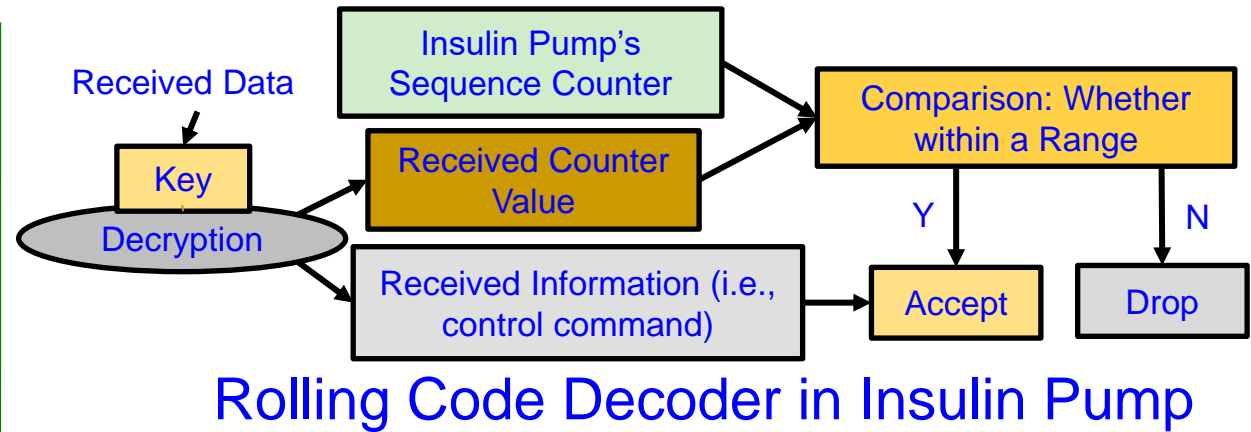
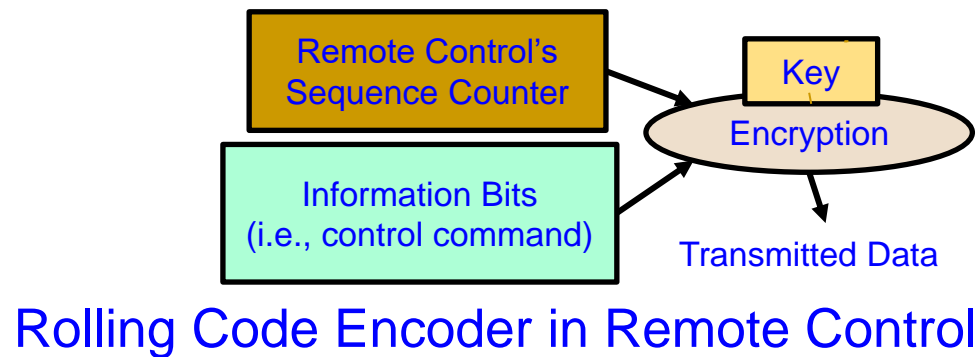
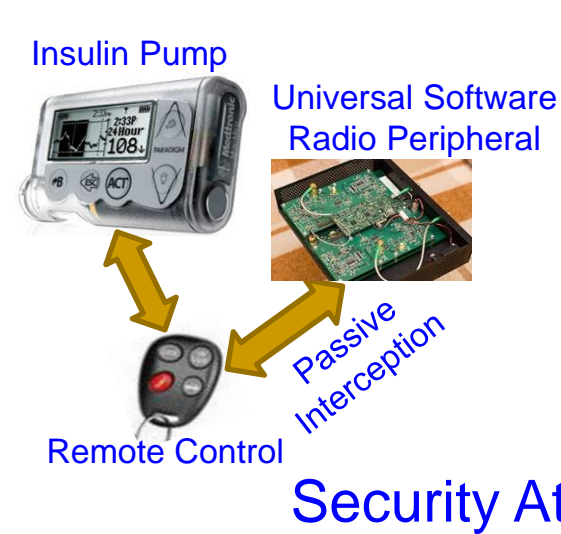
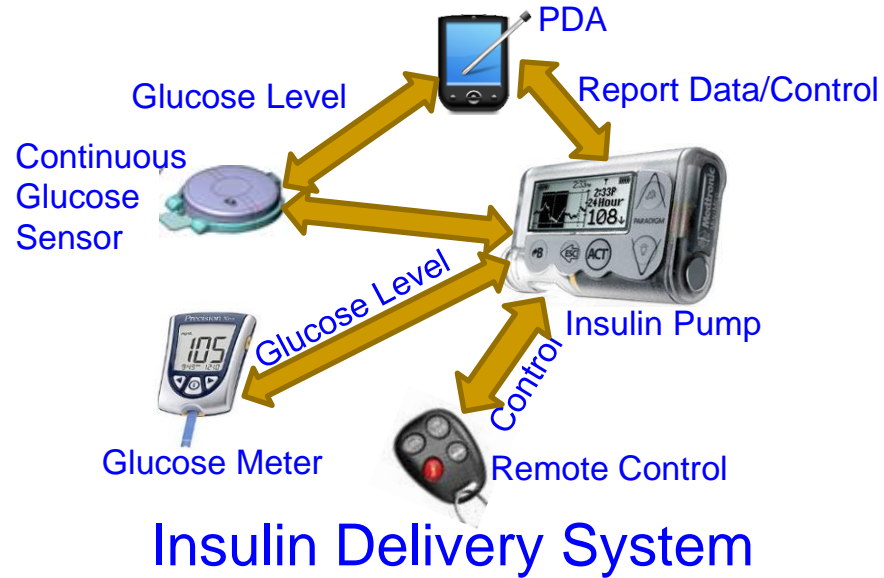

Source: Li and Jha 2011: HEALTH 2011



# Blockchain in Smart Healthcare

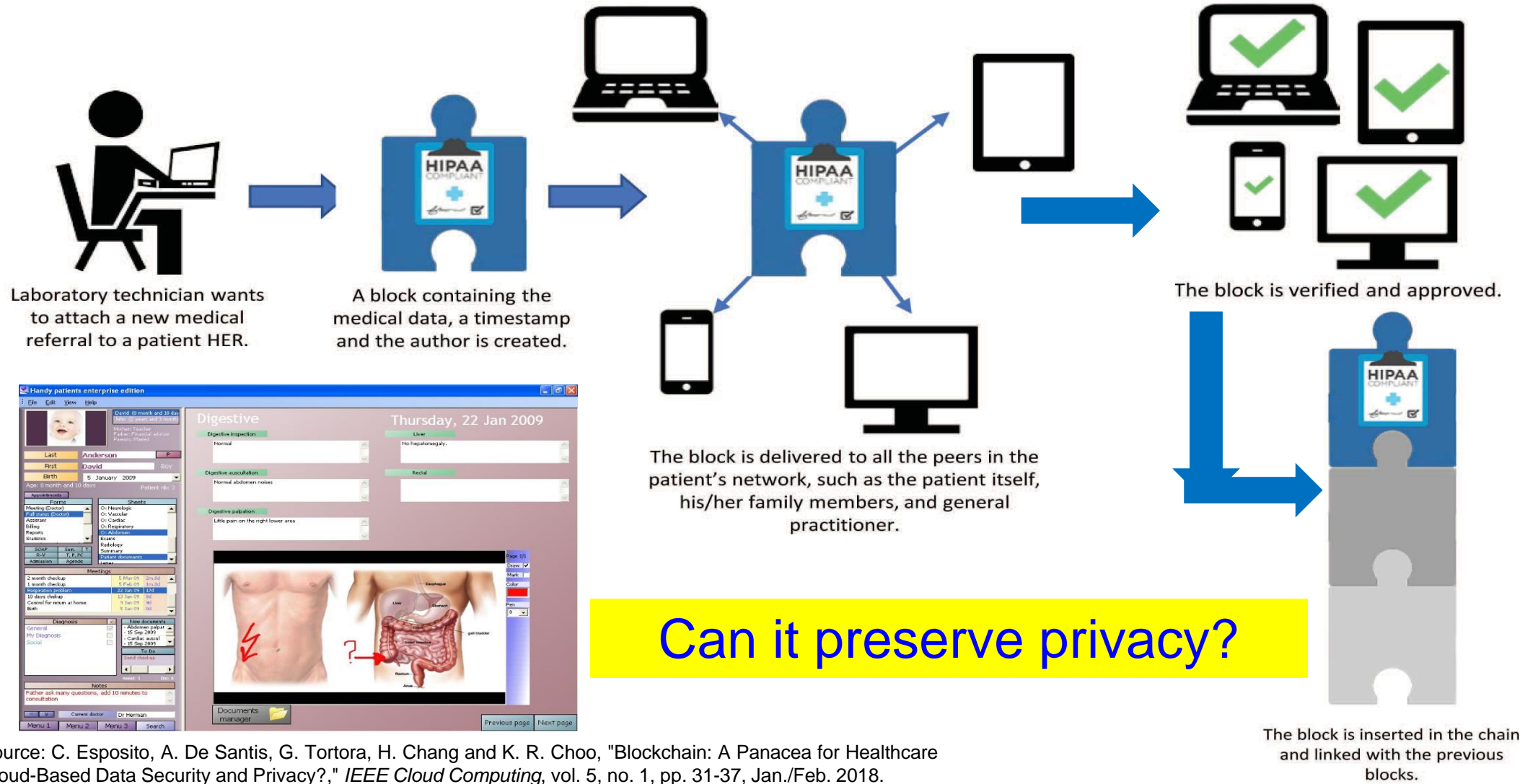

---

# Drawbacks of Existing Cybersecurity Solutions



# IoT/CPS Cybersecurity Solutions – Advantages and Disadvantages

Analysis of selected approaches to security and privacy issues in CE.

Category	Current Approaches	Advantages	Disadvantages
Confidentiality	Symmetric key cryptography	Low computation overhead	Key distribution problem
	Asymmetric key cryptography	Good for key distribution	High computation overhead
Integrity	Message authentication codes	Verification of message contents	Additional computation overhead
Availability	Signature-based authentication	Avoids unnecessary signature computations	Requires additional infrastructure and rekeying scheme
Authentication	Physically unclonable functions (PUFs)	High speed	Additional implementation challenges
	Message authentication codes	Verification of sender	Computation overhead
Nonrepudiation	Digital signatures	Link message to sender	Difficult in pseudonymous systems
Identity privacy	Pseudonym	Disguise true identity	Vulnerable to pattern analysis
	Attribute-based credentials	Restrict access to information based on shared secrets	Require shared secrets with all desired services
Information privacy	Differential privacy	Limit privacy exposure of any single data record	True user-level privacy still challenging
	Public-key cryptography	Integratable with hardware	Computationally intensive
Location privacy	Location cloaking	Personalized privacy	Requires additional infrastructure
Usage privacy	Differential privacy	Limit privacy exposure of any single data record	Recurrent/time-series data challenging to keep private

Source: D. A. Hahn, A. Munir, and S. P. Mohanty, "Security and Privacy Issues in Contemporary Consumer Electronics", *IEEE Consumer Electronics Magazine*, Vol 8, No. 1, Jan 2019, pp. 95--99.

# IT Cybersecurity Solutions Can't be Directly Extended to IoT/CPS Cybersecurity

## IT Cybersecurity

- IT infrastructure may be well protected rooms
- Limited variety of IT network devices
- Millions of IT devices
- Significant computational power to run heavy-duty security solutions
- IT security breach can be costly

## IoT Cybersecurity

- IoT may be deployed in open hostile environments
- Significantly large variety of IoT devices
- Billions of IoT devices
- May not have computational power to run security solutions
- IoT security breach (e.g. in a IoMT device like pacemaker, insulin pump) can be life threatening

Maintaining of Cybersecurity of Electronic Systems, IoT, CPS, needs **Energy**, and affects performance.



# Cybersecurity Measures in Healthcare Cyber-Physical Systems is Hard

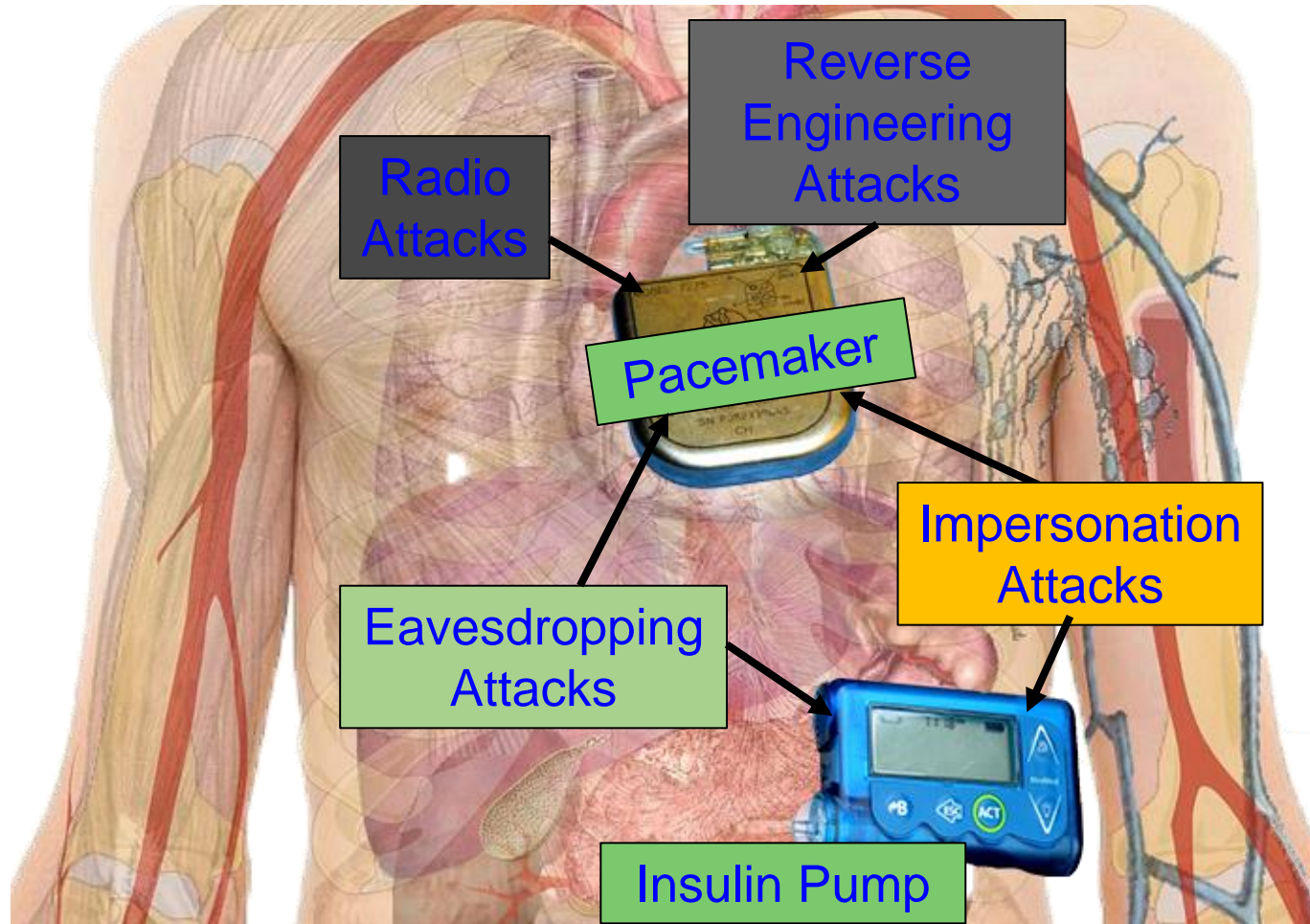

Collectively (WMD+IMD):  
Implantable and Wearable  
Medical Devices (IWMDs)

Implantable and Wearable Medical  
Devices (IWMDs):

- Longer Battery life
- Safer device
- Smaller size
- Smaller weight
- Not much computational capability

# H-CPS Cybersecurity Measures is Hard - Energy Constrained

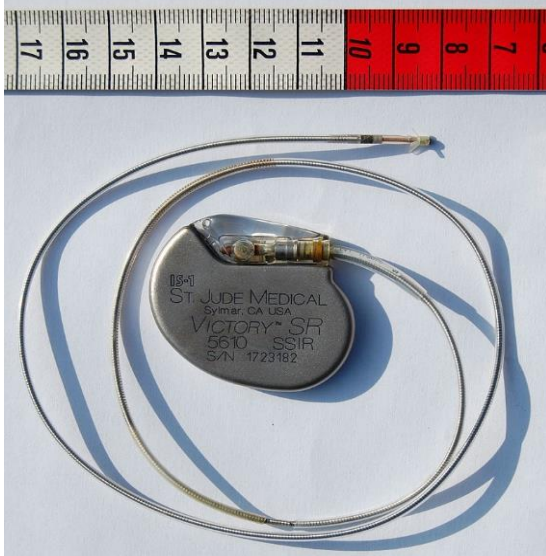

Pacemaker  
Battery Life  
- 10 years



Neurostimulator  
Battery Life  
- 8 years

- Implantable Medical Devices (IMDs) have integrated battery to provide energy to all their functions → Limited Battery Life depending on functions
- Higher battery/energy usage → Lower IMD lifetime
- Battery/IMD replacement → Needs surgical risky procedures

Source: C. Camara, P. Peris-Lopez, and J. E.Tapiadora, "Security and privacy issues in implantable medical devices: A comprehensive survey", *Elsevier Journal of Biomedical Informatics*, Volume 55, June 2015, Pages 272-289.

# Cybersecurity Attacks – Software Vs Hardware Based

## Software Based

- Software attacks via communication channels
- Typically from remote
- More frequent
- Selected Software based:
  - ❑ Denial-of-Service (DoS)
  - ❑ Routing Attacks
  - ❑ Malicious Injection
  - ❑ Injection of fraudulent packets
  - ❑ Snooping attack of memory
  - ❑ Spoofing attack of memory and IP address
  - ❑ Password-based attacks



## Hardware Based

- Hardware or physical attacks
- Maybe local
- More difficult to prevent
- Selected Hardware based:
  - ❑ Hardware backdoors (e.g. Trojan)
  - ❑ Inducing faults
  - ❑ Electronic system tampering/ jailbreaking
  - ❑ Eavesdropping for protected memory
  - ❑ Side channel attack
  - ❑ Hardware counterfeiting

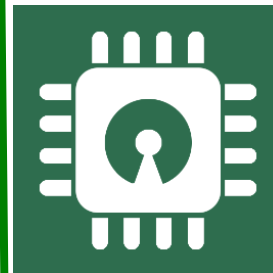

Source: Mohanty ICCE Panel 2018

# Cybersecurity Solutions – Software Vs Hardware Based

## Software Based



- Introduces latency in operation
- Flexible - Easy to use, upgrade and update
- Wider-Use - Use for all devices in an organization
- Higher recurring operational cost
- Tasks of encryption easy compared to hardware – substitution tables
- Needs general purpose processor
- Can't stop hardware reverse engineering

Source: Mohanty ICCE Panel 2018

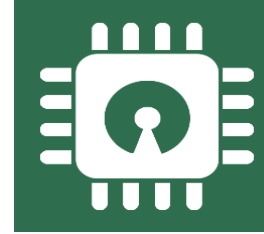

## Hardware Based

- High-Speed operation
- Energy-Efficient operation
- Low-cost using ASIC and FPGA
- Tasks of encryption easy compared to software – bit permutation
- Easy integration in CE systems
- Possible security at source-end like sensors, better suitable for IoT
- Susceptible to side-channel attacks
- Can't stop software reverse engineering



# Cybersecurity Nightmare ← Quantum Computing

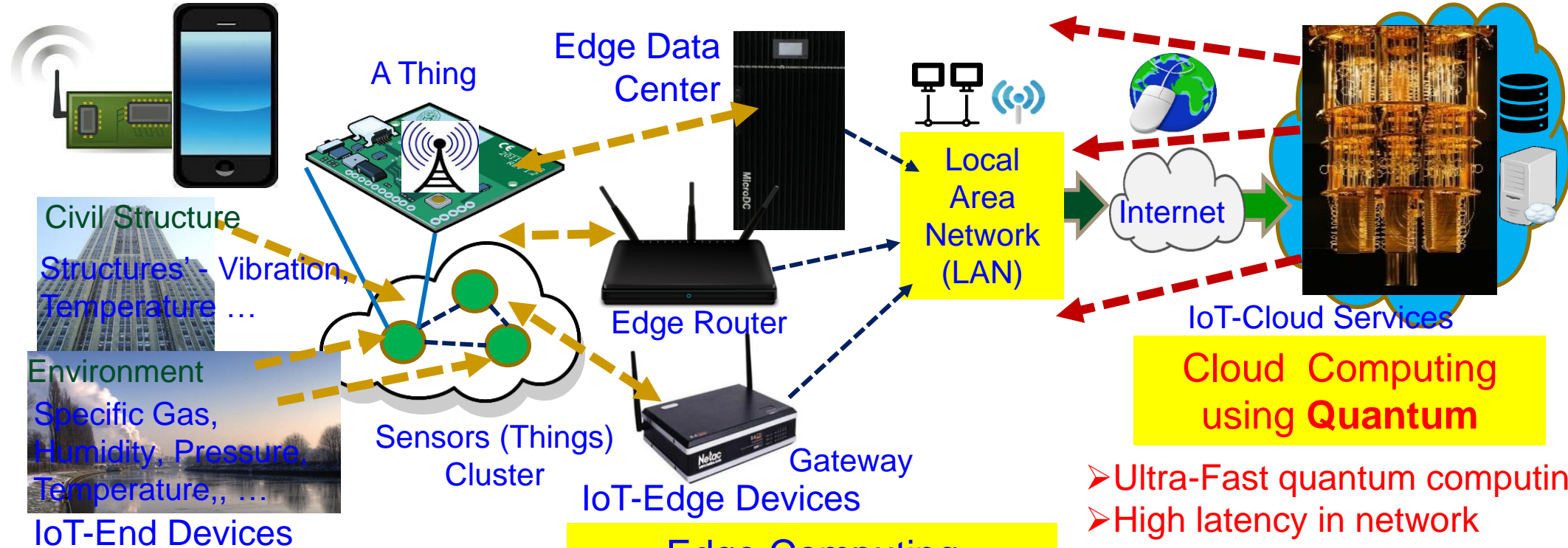

**In-Sensor/End-Device Computing**

- Minimal computational resource
- Negligible latency in network
- Very lightweight security

**Edge Computing**

- Less computational resource
- Minimal latency in network
- Lightweight security

**Cloud Computing using Quantum**

- Ultra-Fast quantum computing resources
- High latency in network
- Breaks every encryption in no time

A quantum computer could break a 2048-bit RSA encryption in 8 hours.



# IoT/CPS Design – Multiple Objectives

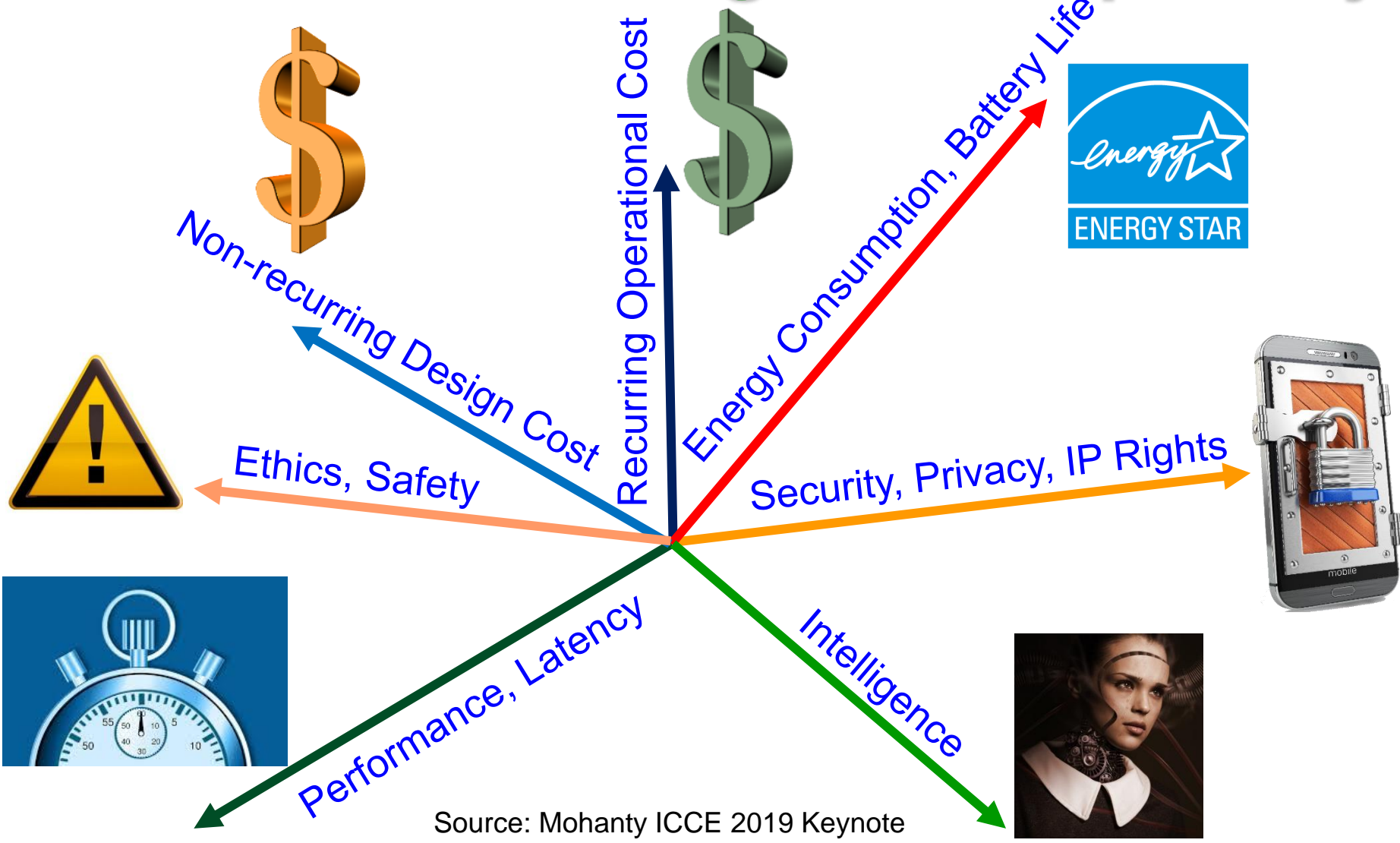

Smart Cities  
Vs  
Smart Villages

Source: Mohanty ICCE 2019 Keynote

# Security by Design (SbD) and/or Privacy by Design (PbD)

Embedding of security/privacy into the architecture (hardware+software) of various products, programs, or services.

Retrofitting: Difficult → Impossible!



Source: <https://teachprivacy.com/tag/privacy-by-design/>



# Security by Design (SbD) and/or Privacy by Design (PbD)



## 7 Fundamental Principles

Proactive not Reactive

Security/Privacy as the Default

Security/Privacy Embedded into Design

Full Functionality - Positive-Sum, not Zero-Sum

End-to-End Security/Privacy - Lifecycle Protection

Visibility and Transparency

Respect for Users

Source: [https://iapp.org/media/pdf/resource\\_center/Privacy%20by%20Design%20-%20%207%20Foundational%20Principles.pdf](https://iapp.org/media/pdf/resource_center/Privacy%20by%20Design%20-%20%207%20Foundational%20Principles.pdf)

# CEI Tradeoffs for Smart Electronic Systems



Security of systems and data.

Cybersecurity

Energy



iPhone 5  
\$0.41/year (3.5 kWh)



Galaxy S III  
\$0.53/year (4.9 kWh)

Source: <https://mashable.com/2012/10/05/energy-efficient-smartphone/>

Energy consumption is minimal and adaptive for longer battery life and lower energy bills.

Intelligence

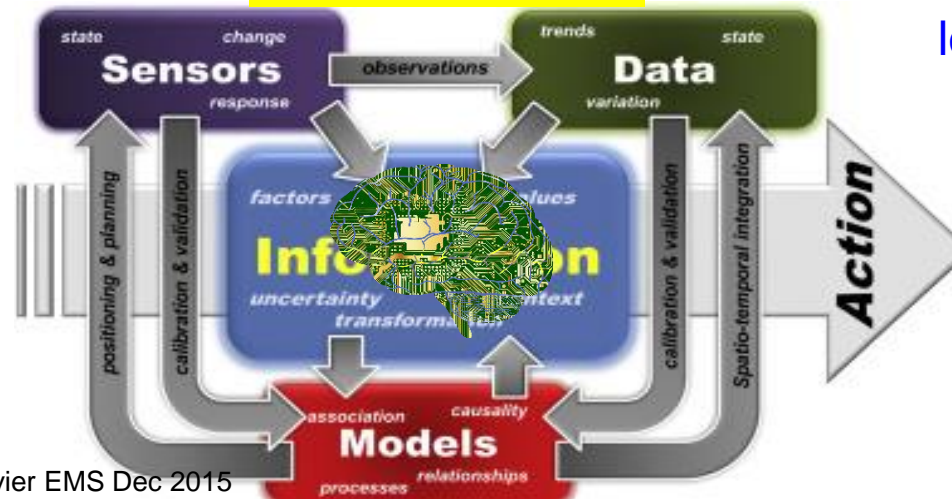

Accurate sensing, analytics, and fast actuation.

Source: Reis, et al. Elsevier EMS Dec 2015

Source: Mohanty iSES 2018 Keynote

# Hardware-Assisted Security (HAS)

- **Hardware-Assisted Security:** Security provided by hardware for:
  - (1) information being processed, **Privacy by Design (PbD)**
  - (2) hardware itself, **Security/Secure by Design (SbD)**
  - (3) overall system
- Additional hardware components used for cybersecurity.
- Hardware design modification is performed.
- System design modification is performed.

**RF Hardware Security**

**Digital Hardware Security – Side Channel**

**Hardware Trojan Protection**

**Information Security, Privacy, Protection**

**Bluetooth Hardware Security**

**Memory Protection**

**Digital Core IP Protection**

Source: Mohanty ICCE 2018 Panel

Source: E. Kougianos, S. P. Mohanty, and R. N. Mahapatra, "Hardware Assisted Watermarking for Multimedia", Special Issue on Circuits and Systems for Real-Time Security and Copyright Protection of Multimedia, Elsevier International Journal on Computers and Electrical Engineering, Vol 35, No. 2, Mar 2009, pp. 339-358..



# Hardware Assisted Security (HAS) or Security-by-Design (SbD) - Advantages

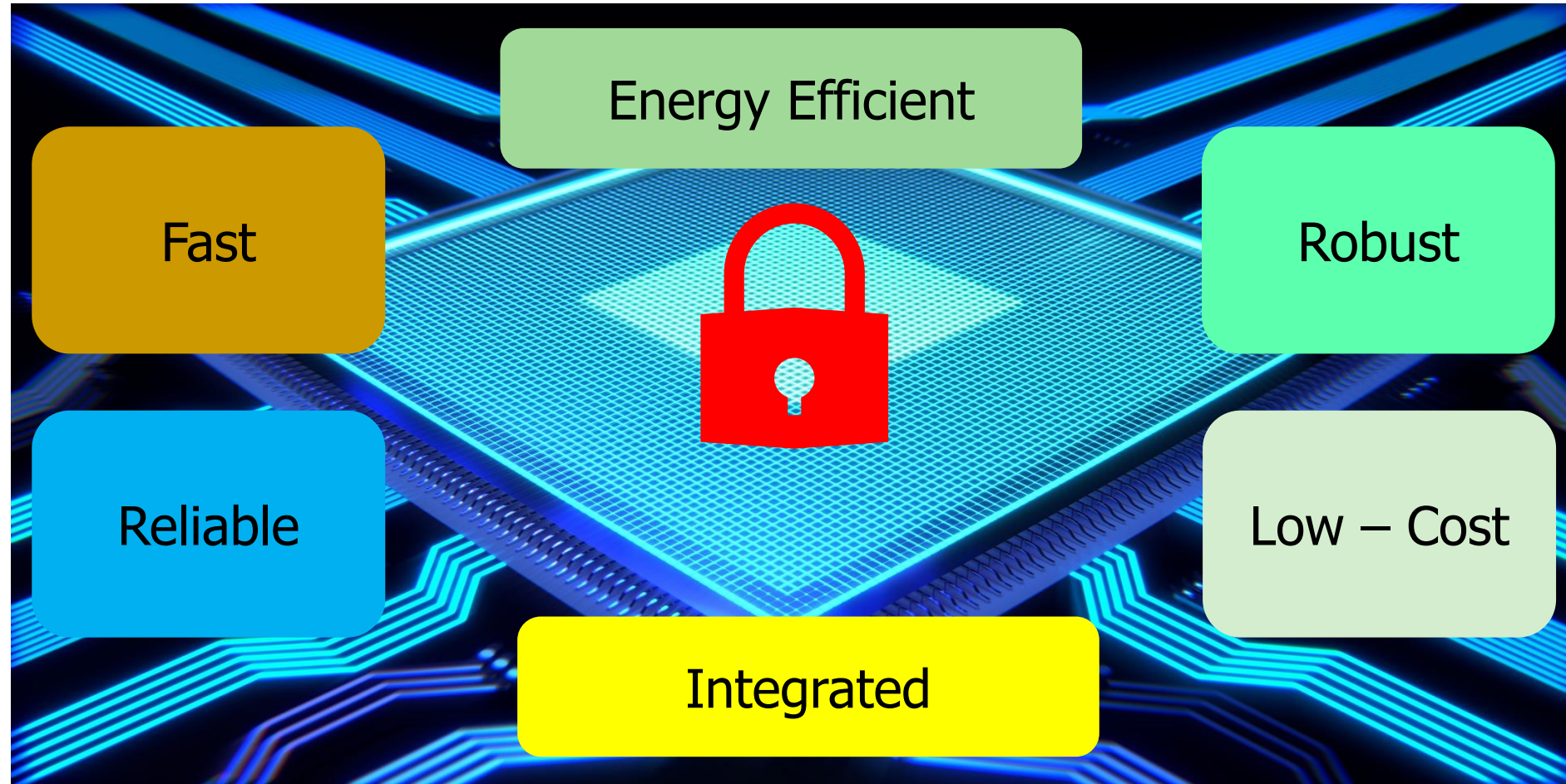



---

# Trustworthy Electronic System

- A selective attributes of electronic system to be trustworthy:
  - ❑ It must maintain integrity of information it is processing.
  - ❑ It must conceal any information about the computation performed through any side channels such as power analysis or timing analysis.
  - ❑ It must perform only the functionality it is designed for, nothing more and nothing less.
  - ❑ It must not malfunction during operations in critical applications.
  - ❑ It must be transparent only to its owner in terms of design details and states.
  - ❑ It must be designed using components from trusted vendors.
  - ❑ It must be built/fabricated using trusted fabs.

# SbD Principle - IoT Design Flow

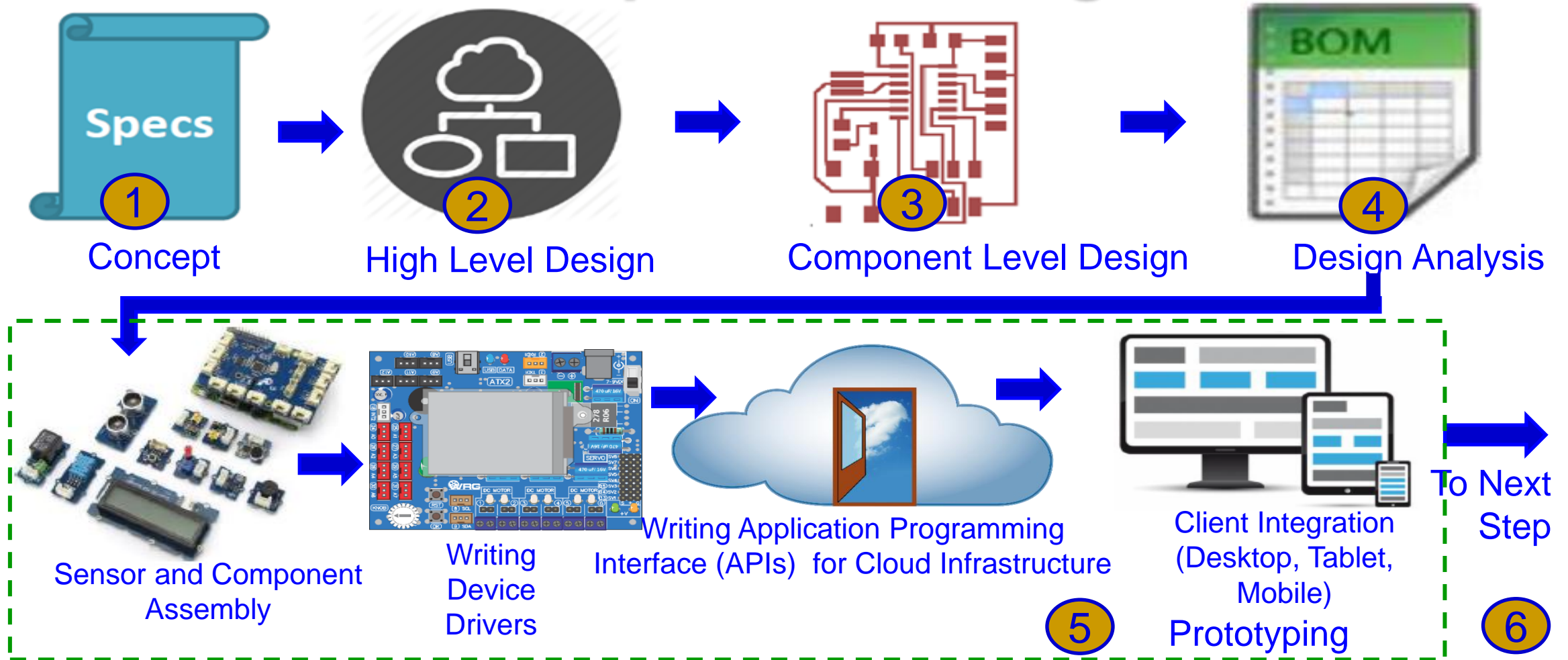

How to integrate cybersecurity and privacy at every stage of design flow?

Source: <http://events.linuxfoundation.org/sites/events/files/slides/Design%20-%20End-to-End%20%20IoT%20Solution%20-%20Shivakumar%20Mathapathi.pdf>

# SbD Principle- IoT Design Flow



How to validate and document cybersecurity and privacy features at every stage of production?

Source: <http://events.linuxfoundation.org/sites/events/files/slides/Design%20-%20End-to-End%20IoT%20Solution%20-%20Shivakumar%20Mathapathi.pdf>

# CPS – IoT-Edge Vs IoT-Cloud

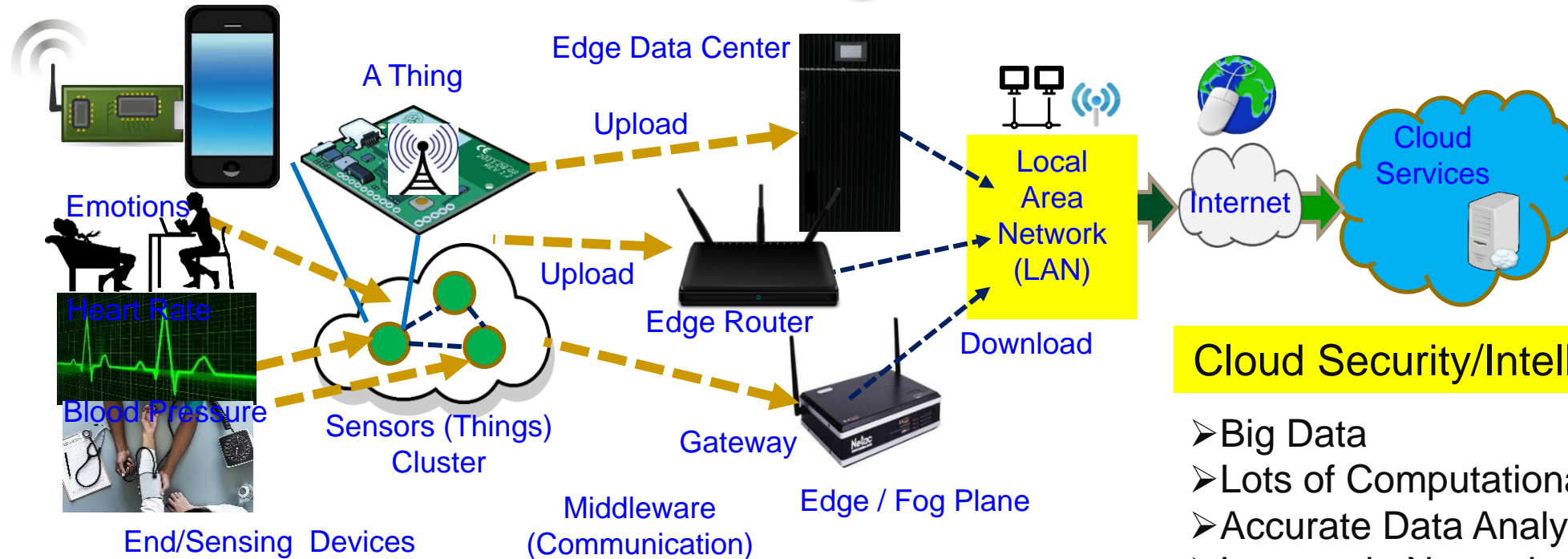

## End Security/Intelligence

- Minimal Data
- Minimal Computational Resource
- Least Accurate Data Analytics
- Very Rapid Response

## Edge Security/Intelligence

- Less Data
- Less Computational Resource
- Less Accurate Data Analytics
- Rapid Response

## Cloud Security/Intelligence

- Big Data
- Lots of Computational Resource
- Accurate Data Analytics
- Latency in Network
- Energy Overhead in Communications

Heavy-Duty ML is more suitable for smart cities

TinyML at End and/or Edge is key for smart villages.



# Hardware Cybersecurity Primitives

## - HSM, TrustZone, TPM, and PUF



Hardware Security Module (HSM)

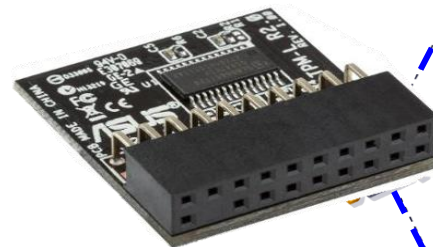

Trusted Platform Module (TPM)

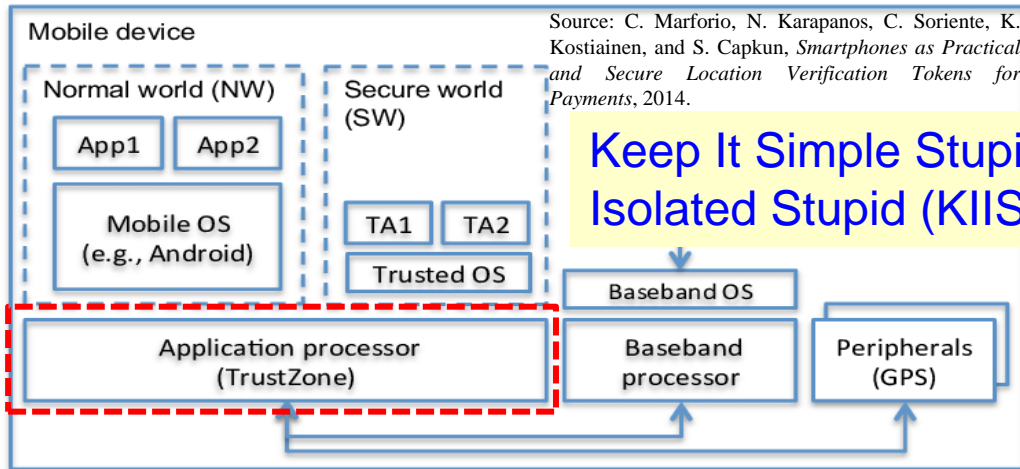
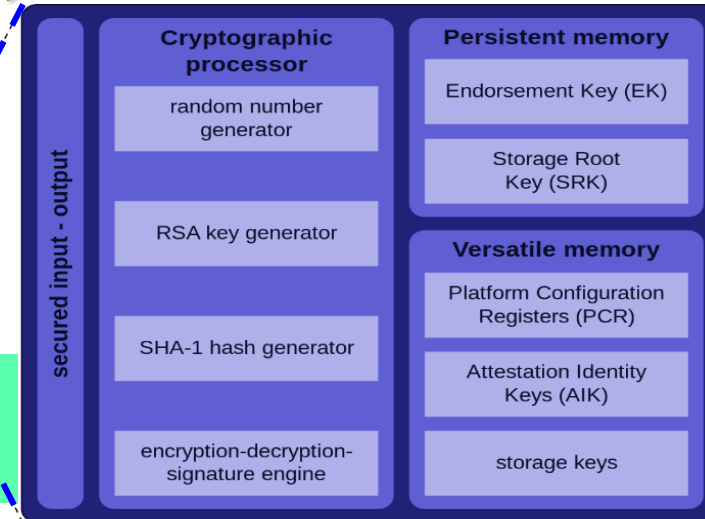

Source: C. Marforio, N. Karapanos, C. Soriente, K. Kostiainen, and S. Capkun, *Smartphones as Practical and Secure Location Verification Tokens for Payments*, 2014.

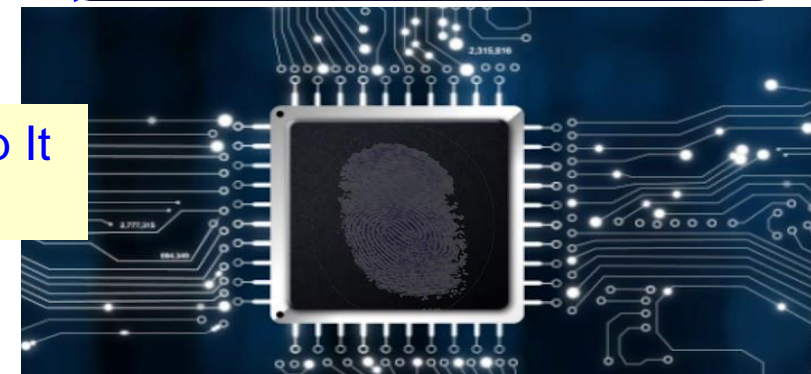

Physical Unclonable Functions (PUF)

Source: Electric Power Research Institute (EPRI)

# Physical Unclonable Functions (PUF)

- Uses manufacturing variations for generating unique set of keys for cryptographic applications.
- Input of PUF is a challenge and output from PUF is response.

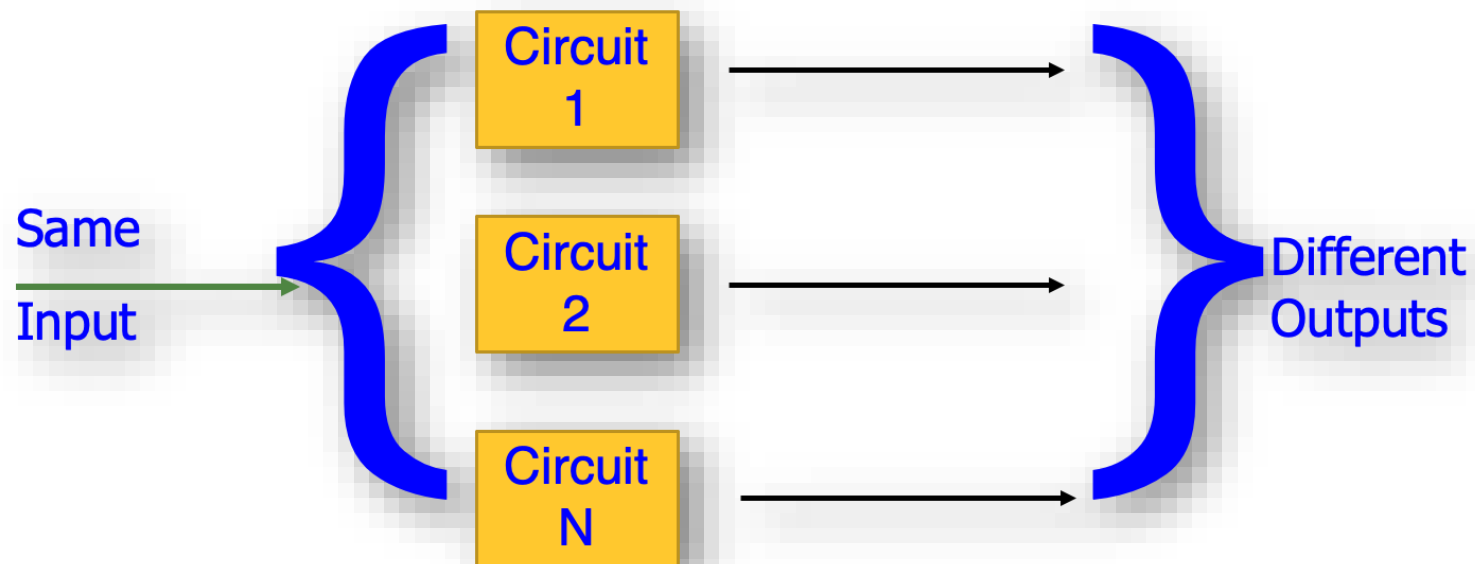

# PUF: Advantages

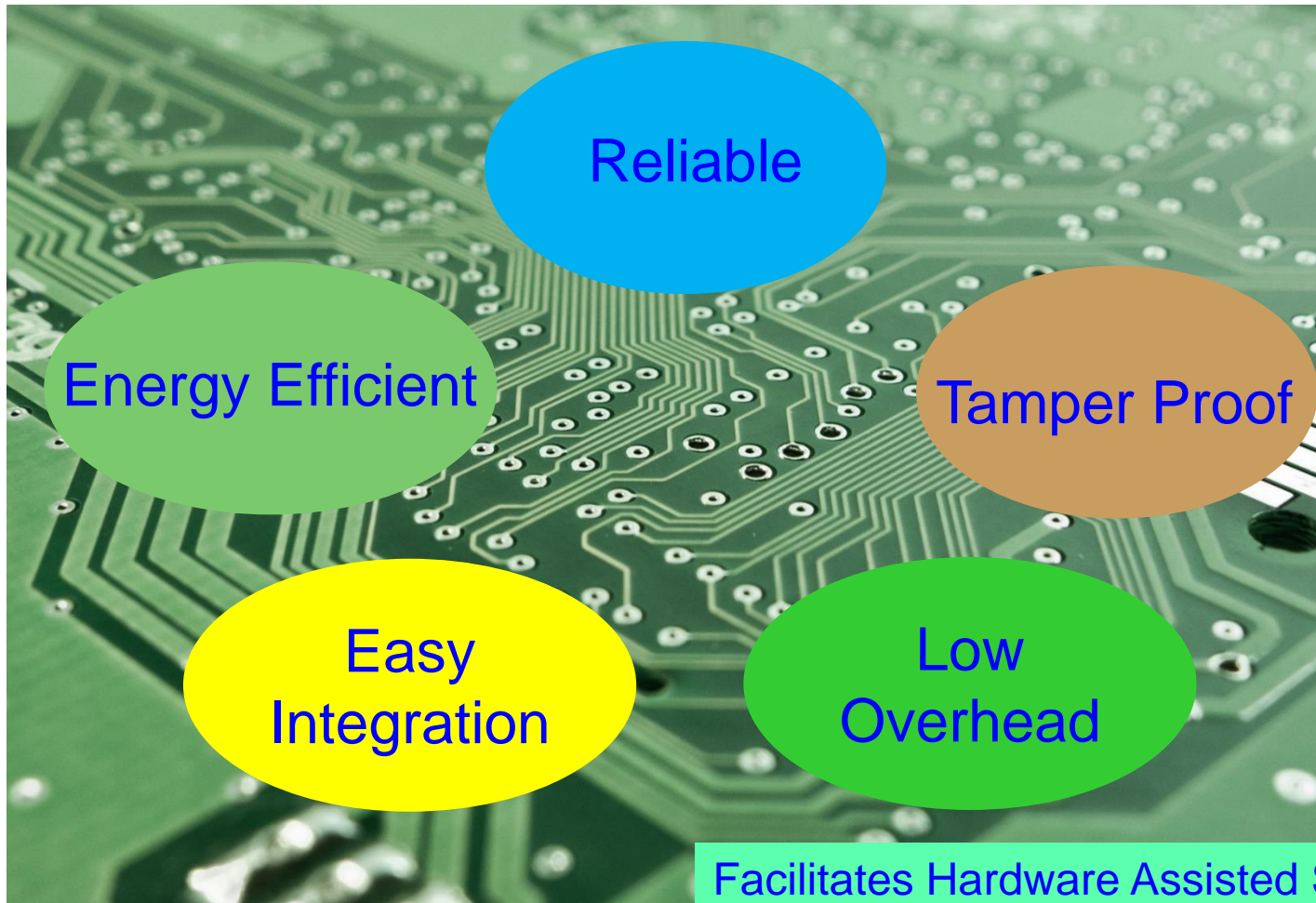

Facilitates Hardware Assisted Security (HAS) or Security-by-Design (SbD).

- A secure fingerprint generation scheme based on process variations in an Integrated Circuit
- PUFs don't store keys in digital memory, rather derive a key based on the physical characteristics of the hardware; thus secure.
- A simple design that generates cryptographically secure keys for the device authentication





# Secure Digital Camera (SDC) – My Invention

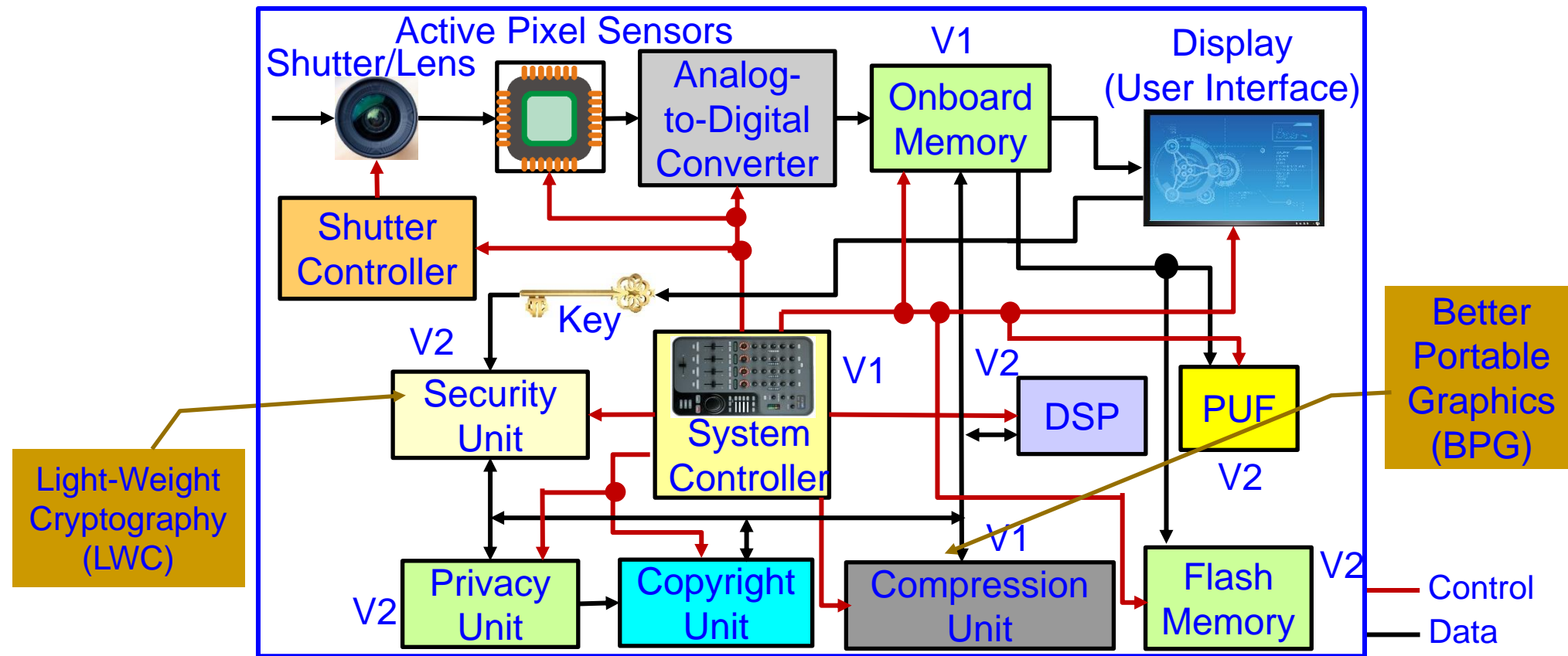

Include additional/alternative hardware/software components and uses DVFS like technology for energy and performance optimization.

Security and/or Privacy by Design (SbD and/or PbD)

Source: S. P. Mohanty, "A Secure Digital Camera Architecture for Integrated Real-Time Digital Rights Management", *Elsevier Journal of Systems Architecture (JSA)*, Volume 55, Issues 10-12, October-December 2009, pp. 468-480.

# PMsec: Our Secure by Design Approach for Robust Security in Healthcare CPS

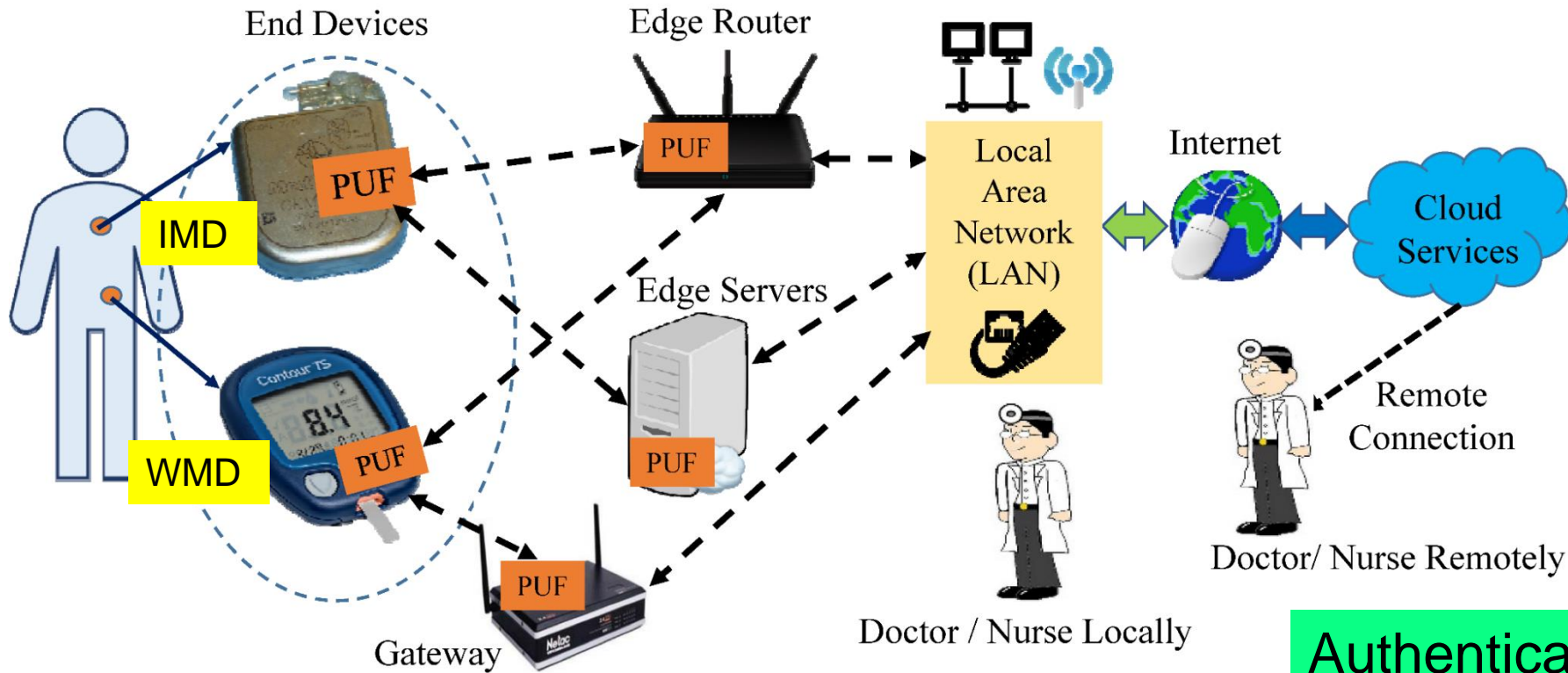

Authenticates Time - 1 sec  
Power Consumption - 200  $\mu$ W

Source: V. P. Yanambaka, S. P. Mohanty, E. Kougianos, and D. Puthal, "PMsec: Physical Unclonable Function-Based Robust and Lightweight Authentication in the Internet of Medical Things", *IEEE Transactions on Consumer Electronics (TCE)*, Volume 65, Issue 3, August 2019, pp. 388--397.

# IoMT Security – Our Proposed PMsec

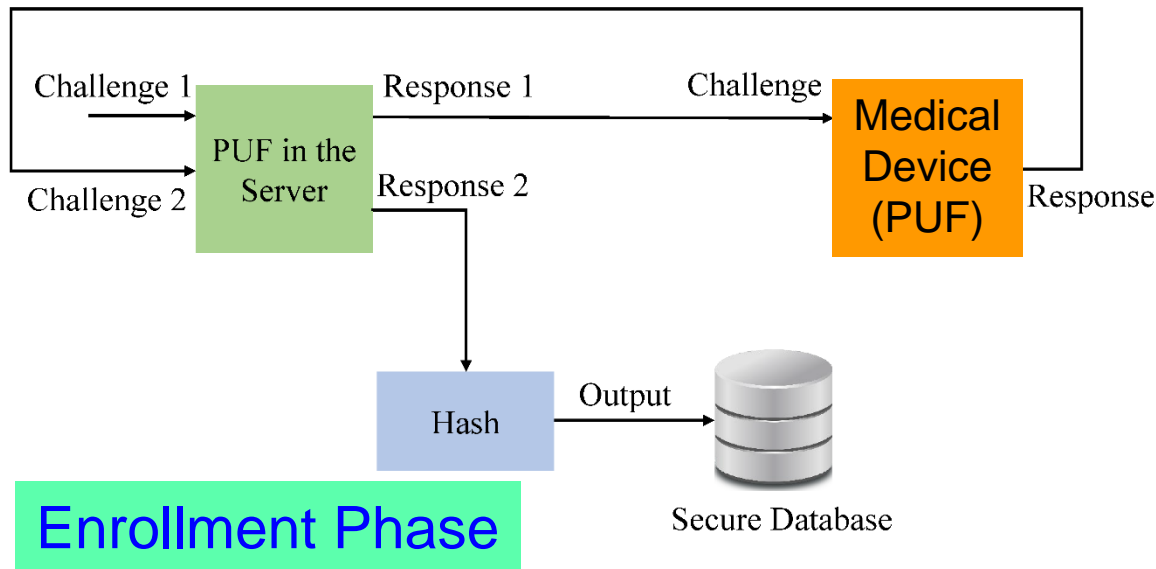

At the Doctor

- When a new IoMT-Device comes for an User

## Device Registration Procedure

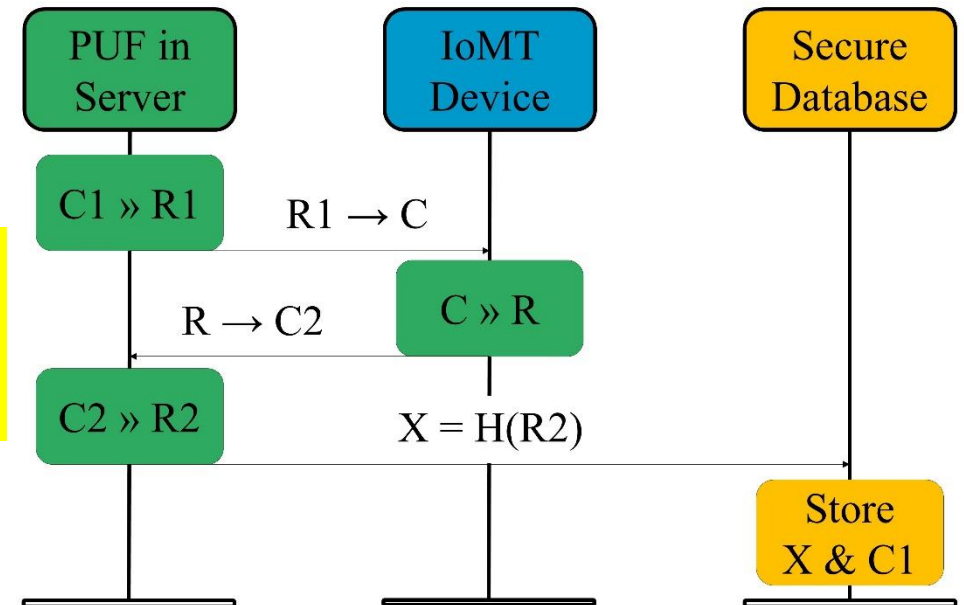

### PUF Security Full Proof:

- Only server PUF Challenges are stored, not Responses
- Impossible to generate Responses without PUF

Source: V. P. Yanambaka, S. P. Mohanty, E. Kougianos, and D. Puthal, "PMsec: Physical Unclonable Function-Based Robust and Lightweight Authentication in the Internet of Medical Things", *IEEE Transactions on Consumer Electronics (TCE)*, Volume 65, Issue 3, August 2019, pp. 388--397.

# IoMT Security – Our Proposed PMsec

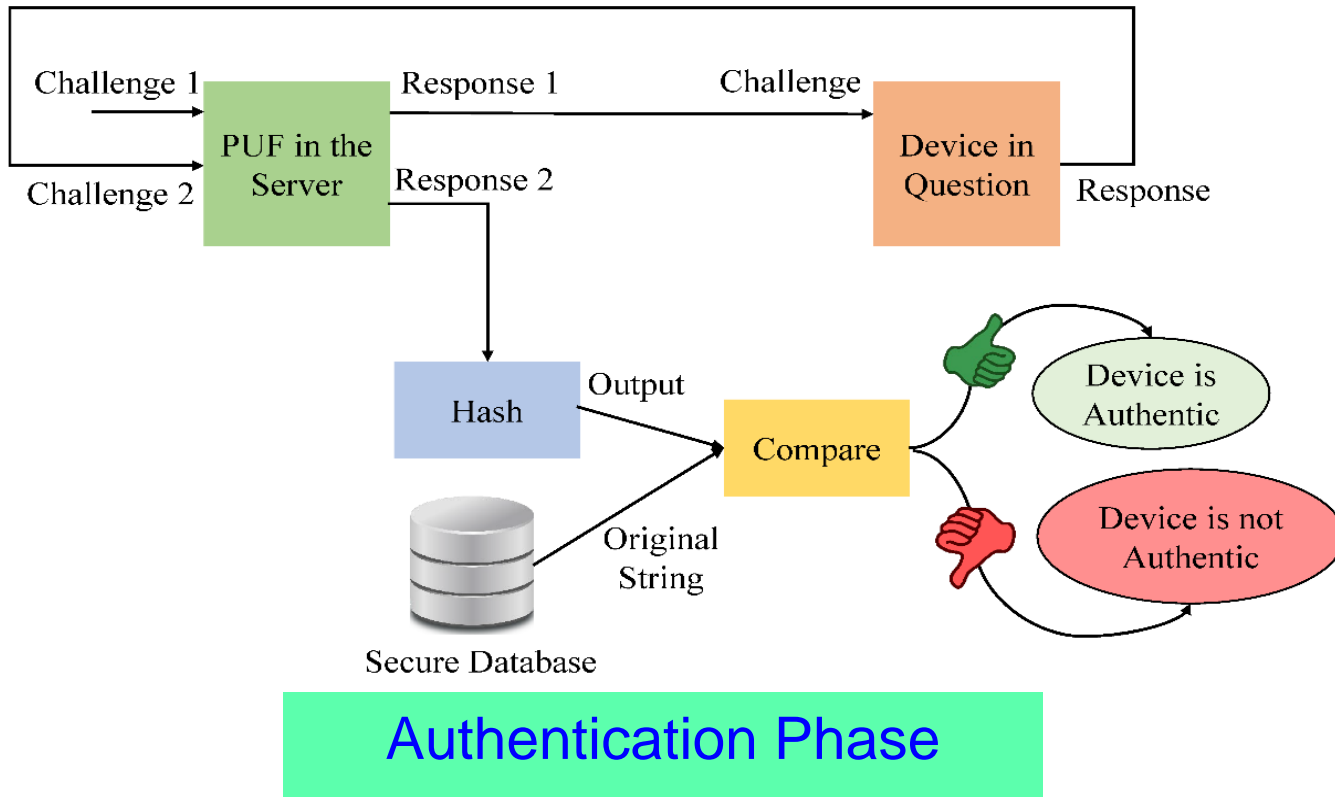

**At the Doctor**

➤ When doctor needs to access an existing IoMT-device

## Device Authentication Procedure

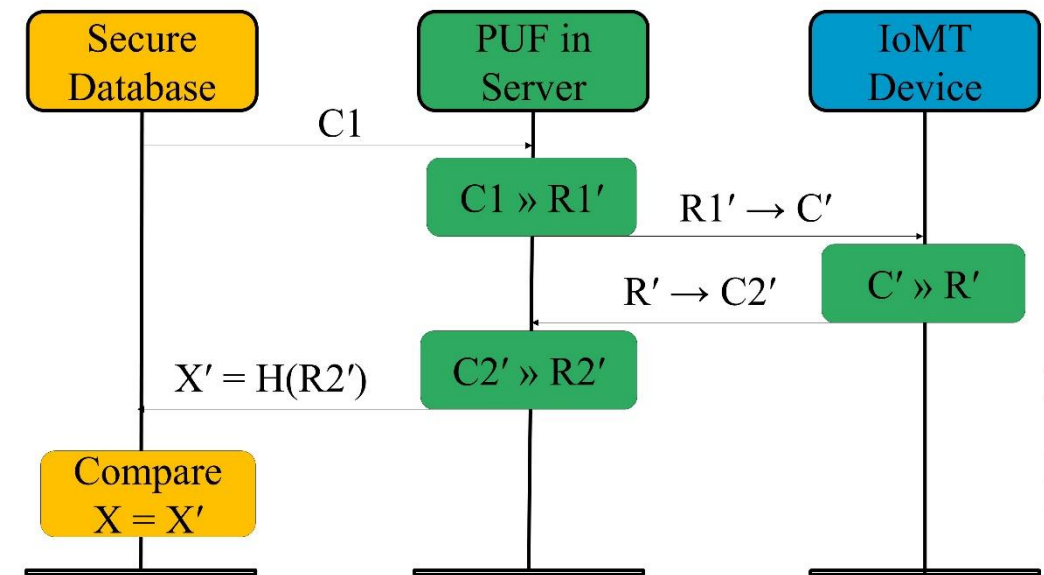

Source: V. P. Yanambaka, S. P. Mohanty, E. Kougianos, and D. Puthal, "PMsec: Physical Unclonable Function-Based Robust and Lightweight Authentication in the Internet of Medical Things", *IEEE Transactions on Consumer Electronics (TCE)*, Volume 65, Issue 3, August 2019, pp. 388--397.



# IoMT Security – Our Proposed PMsec

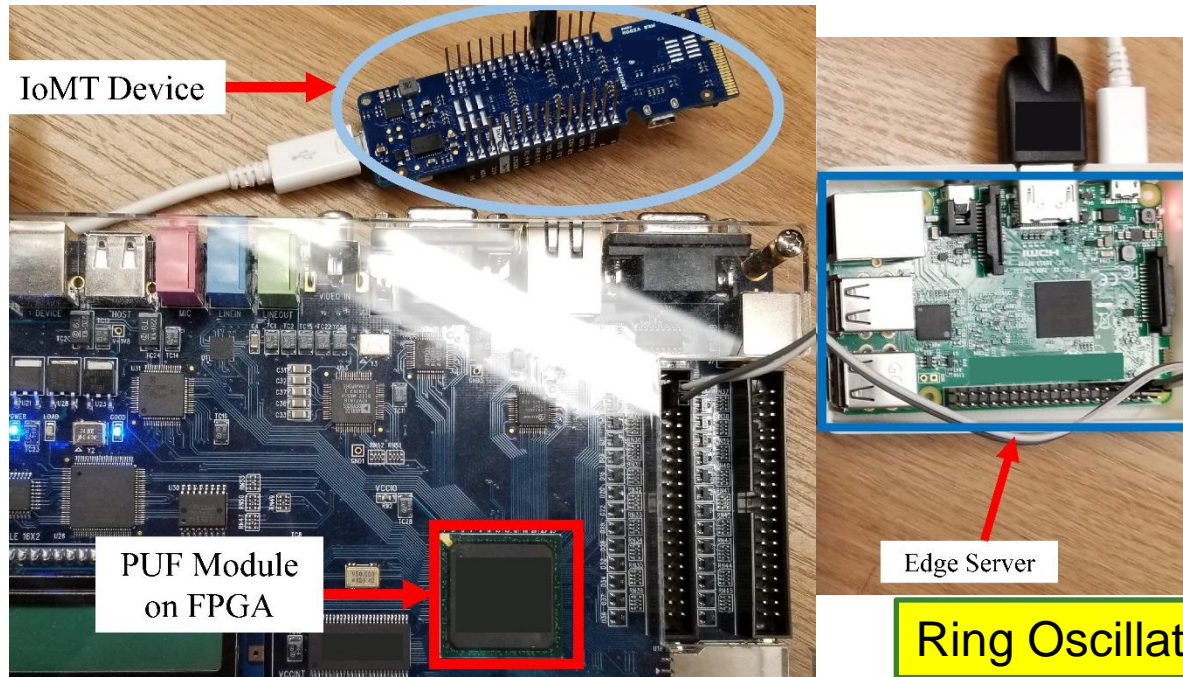

Average Power Overhead  
– 200  $\mu$ W

Ring Oscillator PUF – 64-bit, 128-bit, ...

Proposed Approach Characteristics	Value (in a FPGA / Raspberry Pi platform)
Time to Generate the Key at Server	800 ms
Time to Generate the Key at IoMT Device	800 ms
Time to Authenticate the Device	1.2 sec - 1.5 sec

Source: V. P. Yanambaka, S. P. Mohanty, E. Kougianos, and D. Puthal, "PMsec: Physical Unclonable Function-Based Robust and Lightweight Authentication in the Internet of Medical Things", *IEEE Transactions on Consumer Electronics*, Vol 65, No 3, Aug 2019, pp. 388--397.

# Secure-iGLU - Our Intelligent Non-Invasive Glucose Monitoring with Insulin Control Device

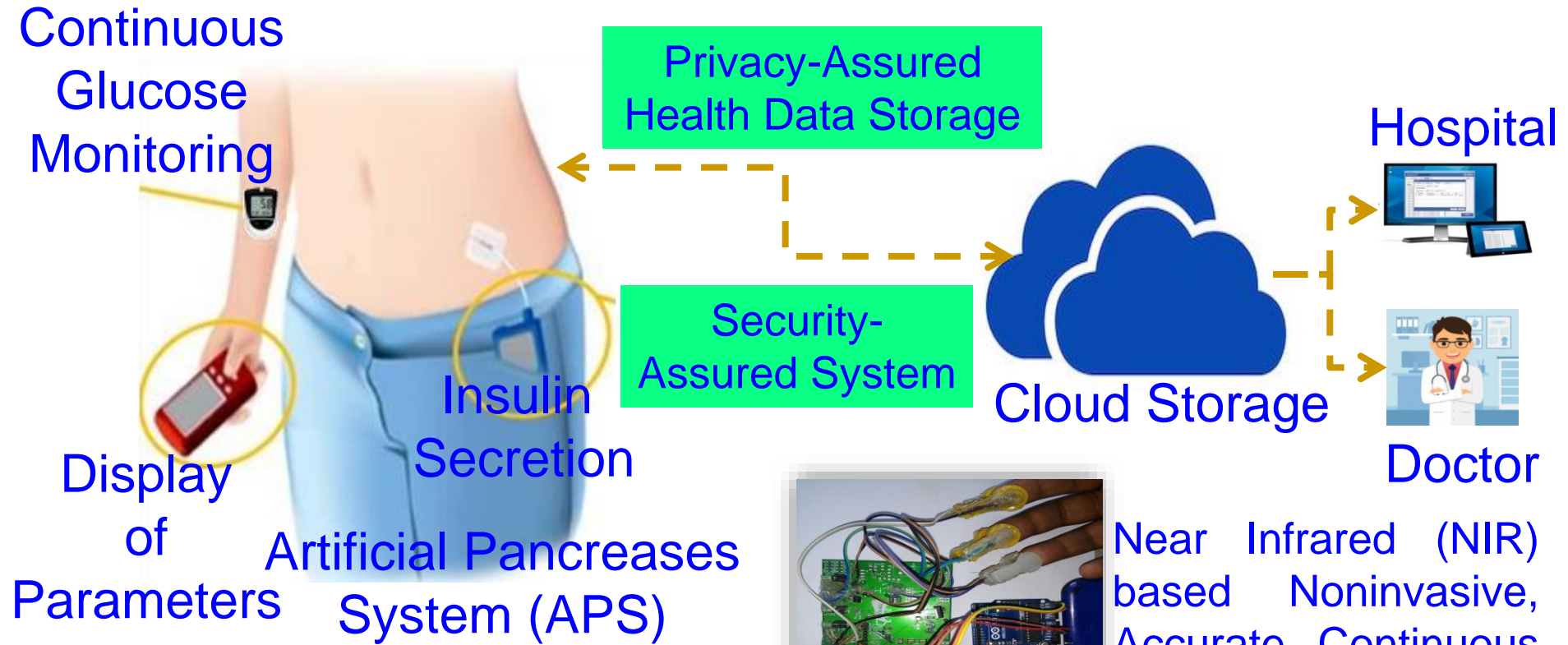

Smart Healthcare (H-CPS)  
 → Security, Privacy, ...

P. Jain, A. M. Joshi, and S. P. Mohanty, "iGLU: An Intelligent Device for Accurate Non-Invasive Blood Glucose-Level Monitoring in Smart Healthcare", *IEEE Consumer Electronics Magazine (MCE)*, Vol. 9, No. 1, January 2020, pp. 35–42.

# Secure-iGLU: Accurate Glucose Level Monitoring and Secure Insulin Delivery

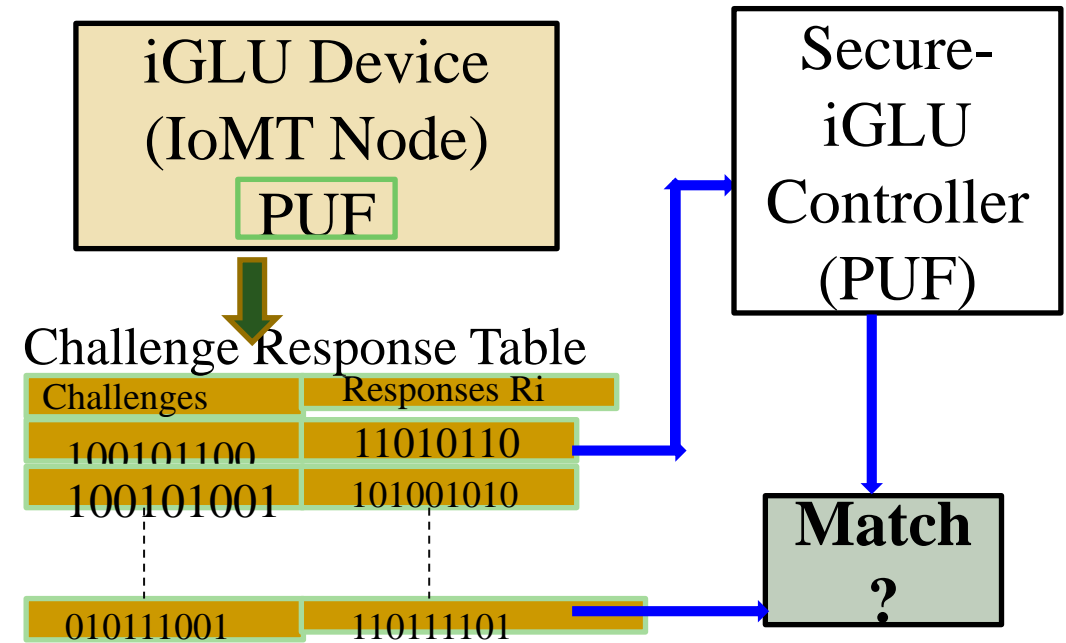
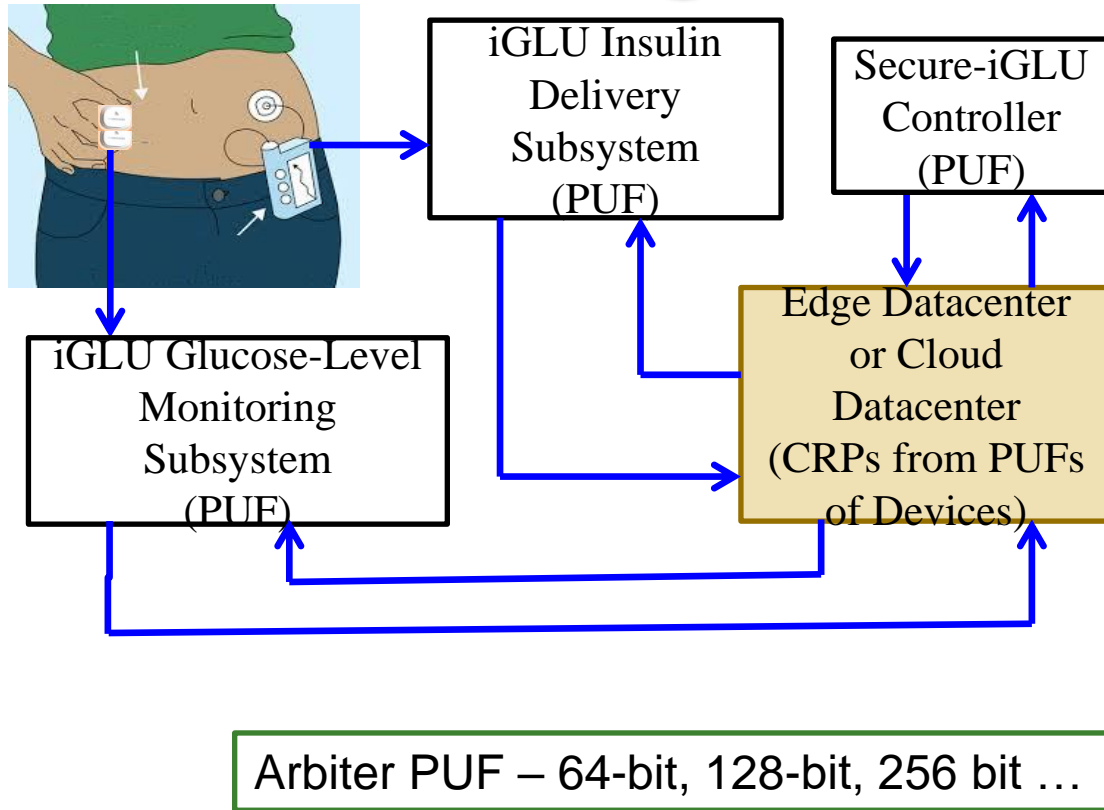

Source: A. M. Joshi, P. Jain, and S. P. Mohanty, "Secure-iGLU: A Secure Device for Noninvasive Glucose Measurement and Automatic Insulin Delivery in IoMT Framework", *Proceedings of the 19th IEEE Computer Society Annual Symposium on VLSI (ISVLSI)*, 2020, pp. 440-445.



# Our Smart-Yoga Pillow (SaYoPillow) with TinyML and Blockchain based Security

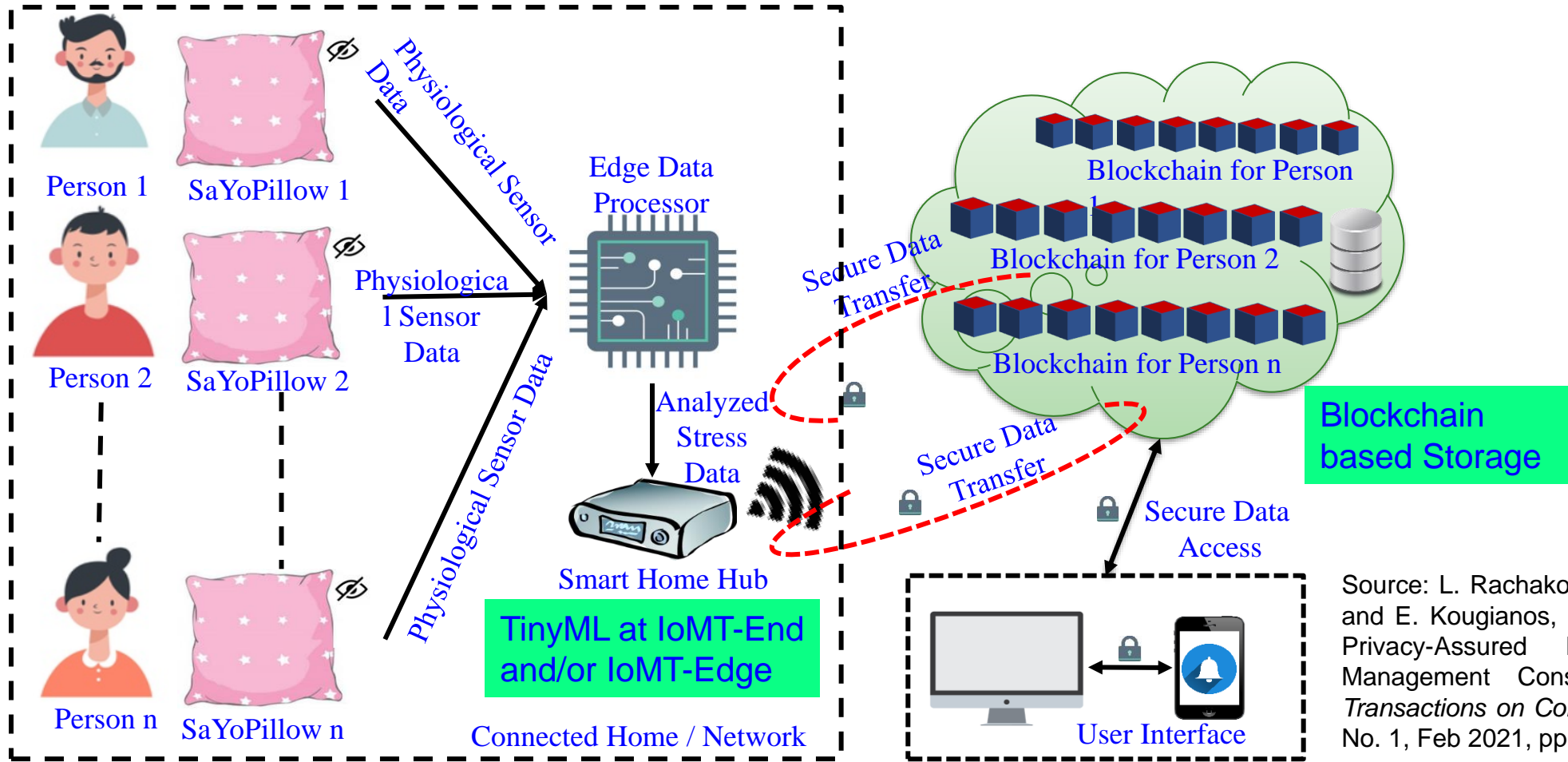

Source: L. Rachakonda, A. K. Bapatla, S. P. Mohanty, and E. Kougianos, "SaYoPillow: Blockchain-Integrated Privacy-Assured IoMT Framework for Stress Management Considering Sleeping Habit", *IEEE Transactions on Consumer Electronics (TCE)*, Vol. 67, No. 1, Feb 2021, pp. 20-29.





# Our Smart Blood Alcohol Concentration Tracking Mechanism in Healthcare CPS - BACTmobile

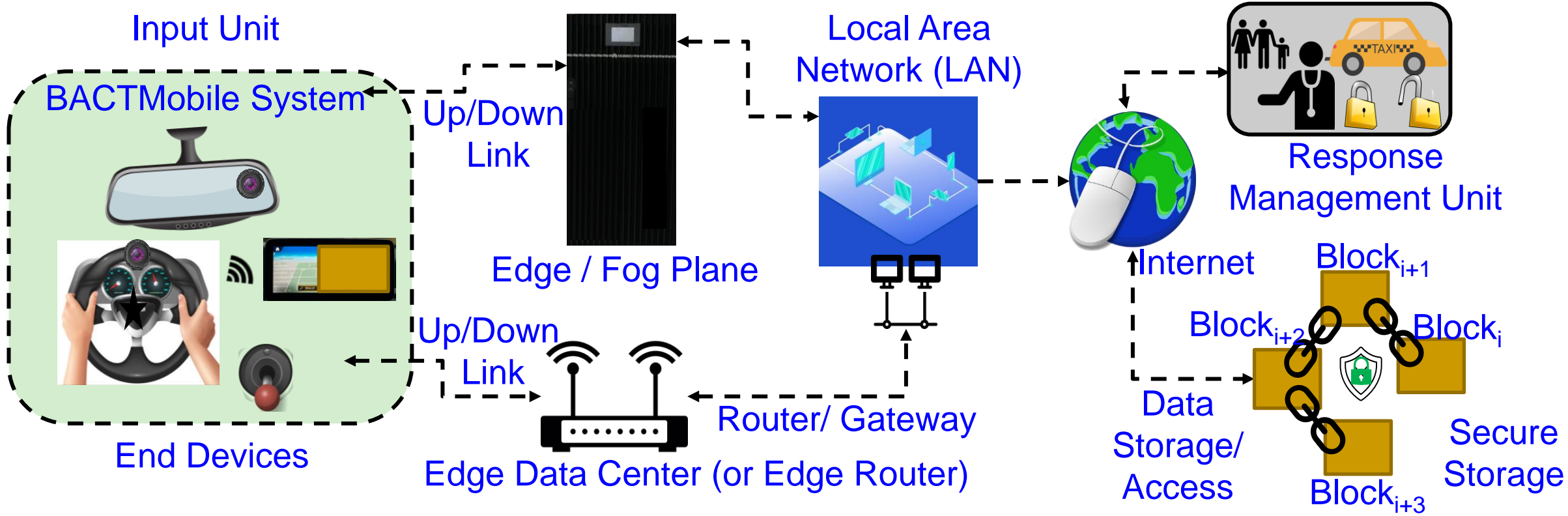

Source: L. Rachakonda, A. K. Bapatla, **S. P. Mohanty**, and E. Kougianos, "BACTmobile: A Smart Blood Alcohol Concentration Tracking Mechanism for Smart Vehicles in Healthcare CPS Framework", *Springer Nature Computer Science (SN-CS)*, Vol. 3, No. 3, May 2022, Article: 236, 24-pages, DOI: <https://doi.org/10.1007/s42979-022-01142-9>.

# IoT-Friendly Blockchain – EasyChain: Our Proof-of-Authentication (PoAh) based

Blockchain doesn't inherently guarantee security and privacy.

IoT-End and IoT-Edge Devices don't have enough horse power to run PoW/PoS like heavy duty consensus algorithms.

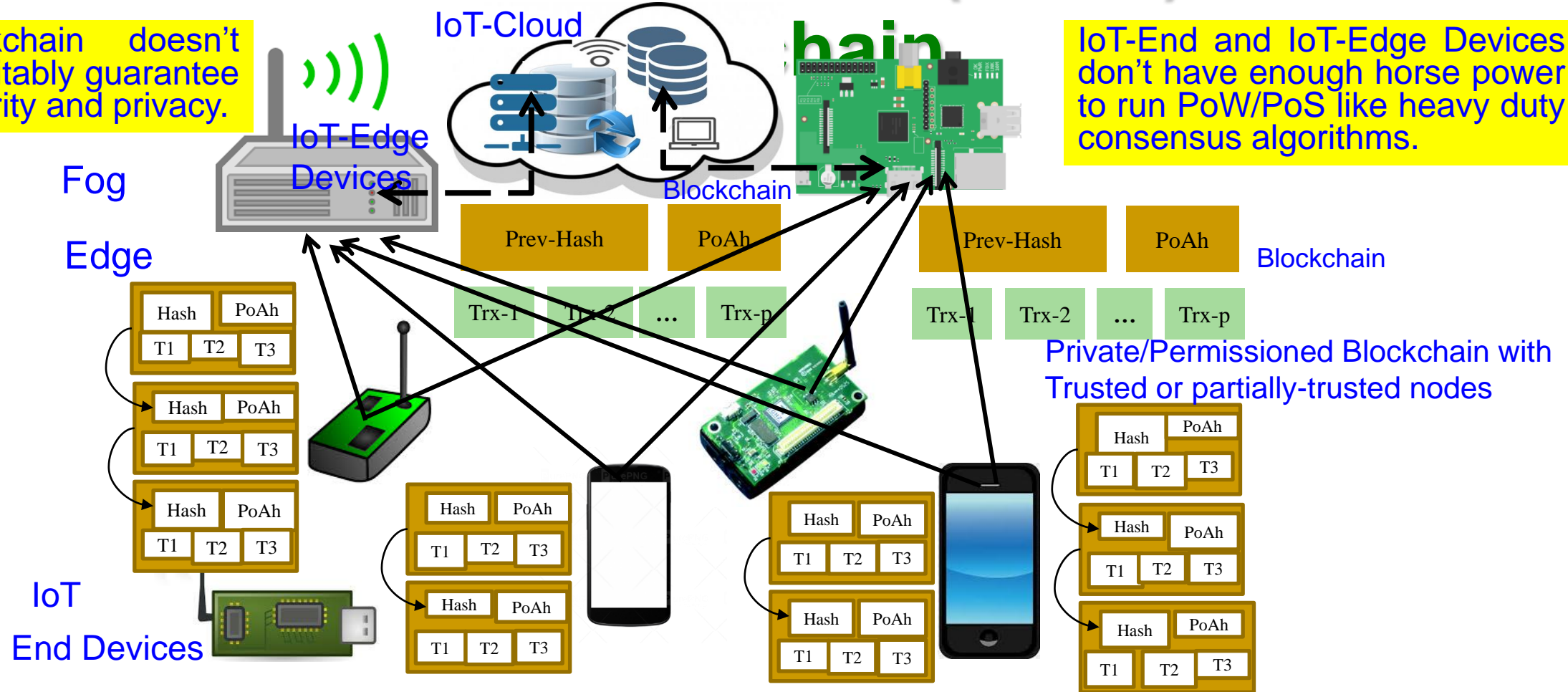

Source: D. Puthal and S. P. Mohanty, "Proof of Authentication: IoT-Friendly Blockchains", *IEEE Potentials Magazine*, Vol. 38, No. 1, January 2019, pp. 26--29.

# Our EasyChain: Proof-of-Authentication (PoAh)

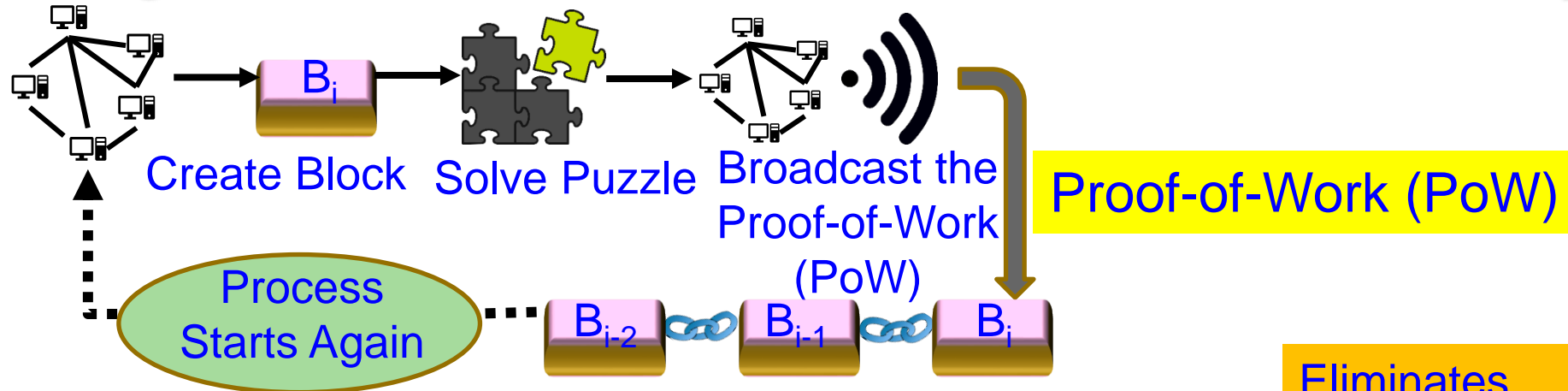

## Proof of Authentication (PoAh)

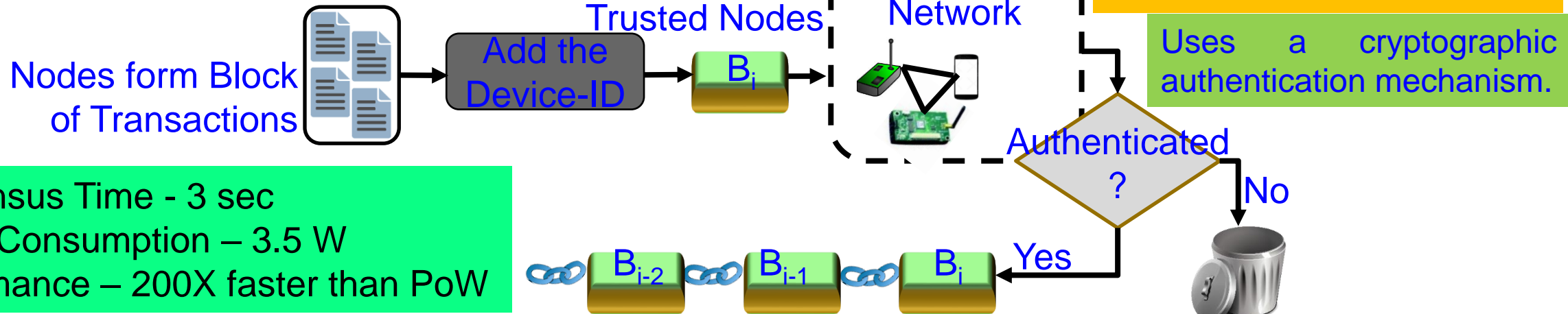

Consensus Time - 3 sec  
 Power Consumption – 3.5 W  
 Performance – 200X faster than PoW

Source: D. Puthal and S. P. Mohanty, "Proof of Authentication: IoT-Friendly Blockchains", *IEEE Potentials Magazine*, Vol. 38, No. 1, January 2019, pp. 26--29.



# Our EasyChain with PoAh Runs in Resource Constrained Environment

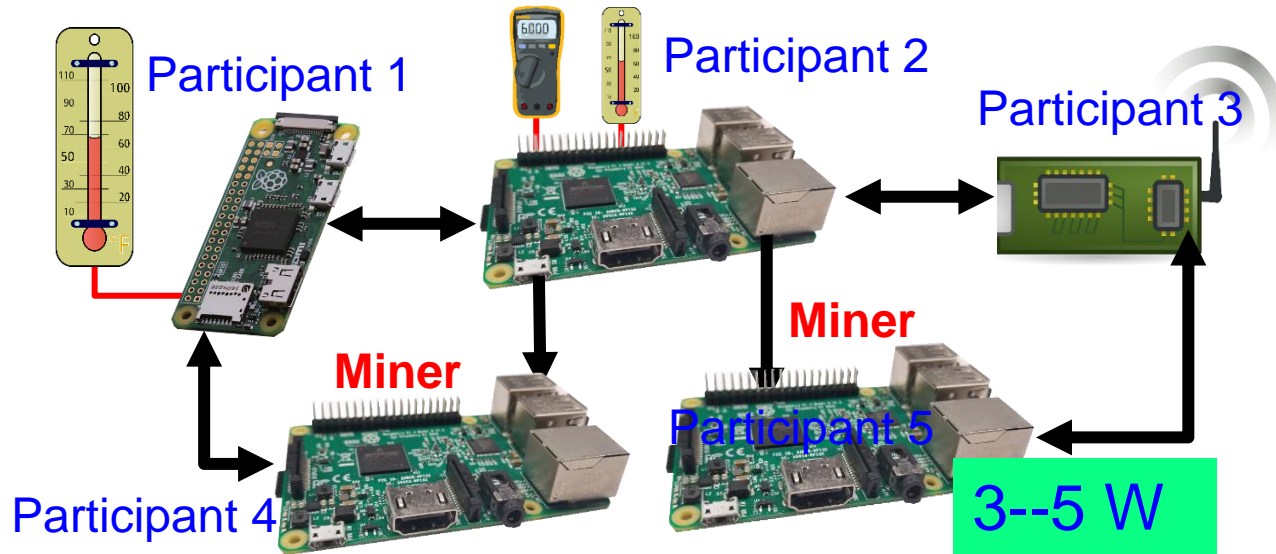

Our PoAh-Chain Runs even in IoT-end devices.

Blockchain using PoW Needs Significant Resource

500,0000 W

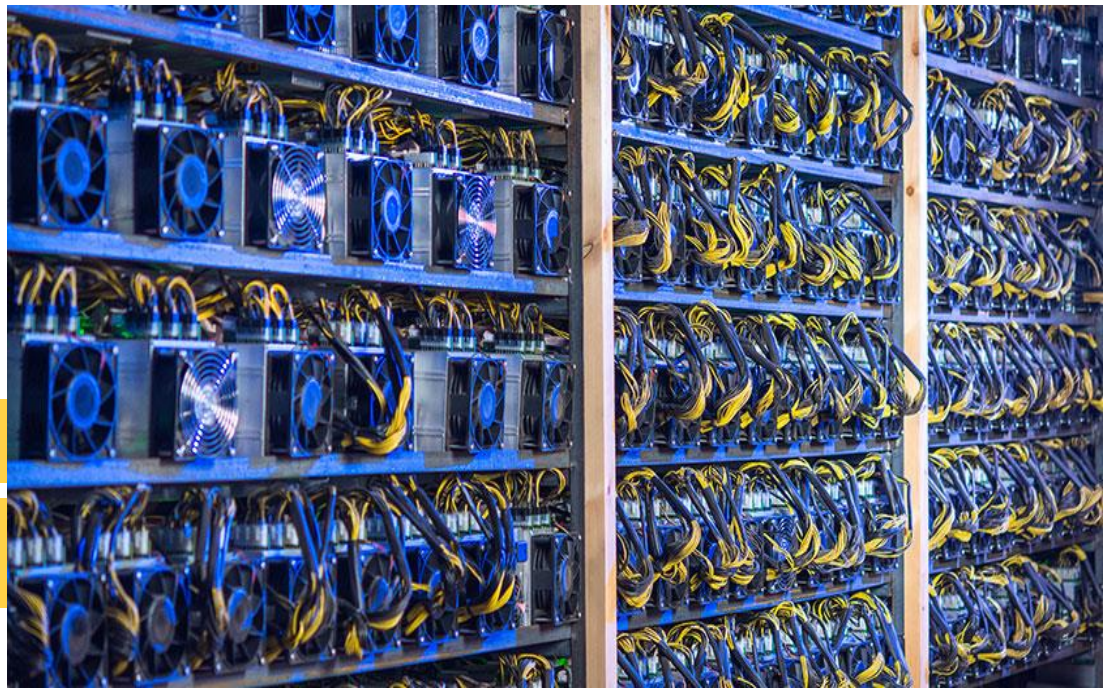

Source: <https://www.iea.org/newsroom/news/2019/july/bitcoin-energy-use-mined-the-gap.html>

Source: D. Puthal, S. P. Mohanty, V. P. Yanambaka, and E. Kougianos, "PoAh: A Novel Consensus Algorithm for Fast Scalable Private Blockchain for Large-scale IoT Frameworks", *arXiv Computer Science*, [arXiv:2001.07297](https://arxiv.org/abs/2001.07297), January 2020, 26-pages.

# We Proposed World's First Hardware-Integrated Blockchain (PUFchain) that is Scalable, Energy-Efficient, and Fast

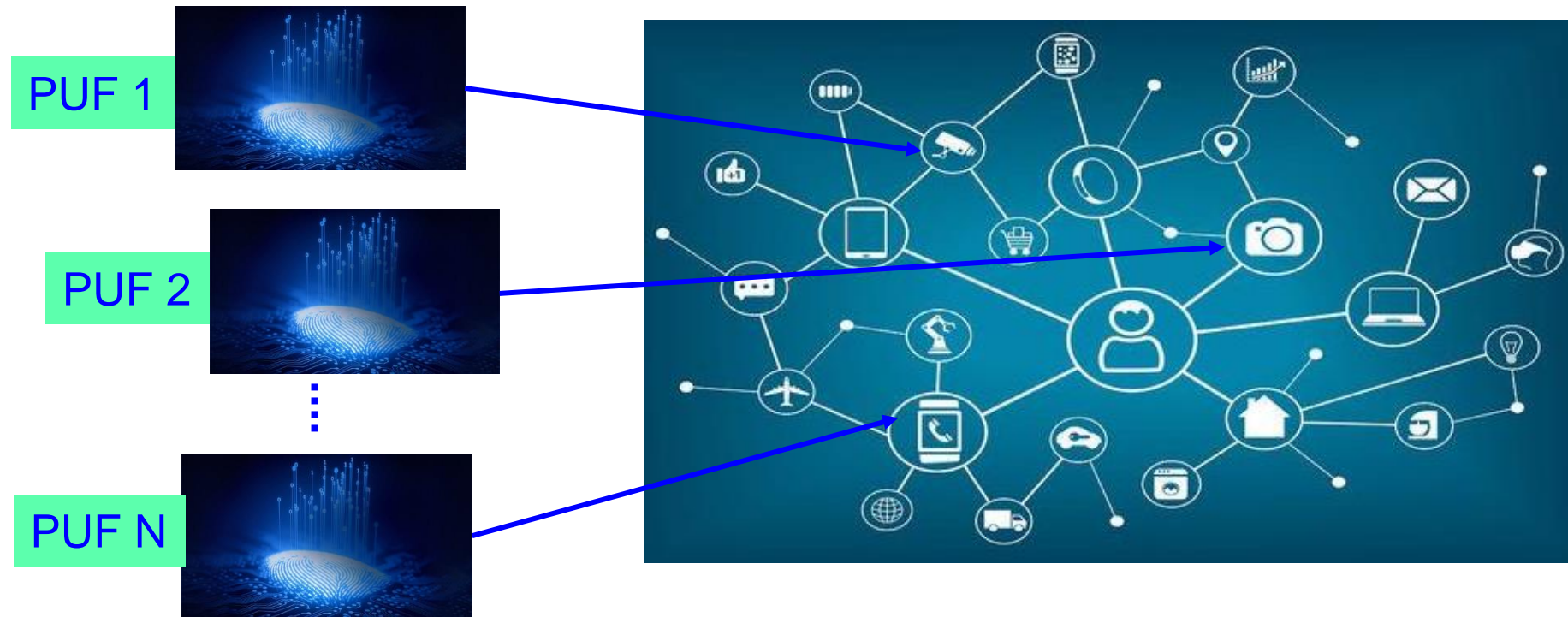

Source: S. P. Mohanty, V. P. Yanambaka, E. Kougianos, and D. Puthal, "PUFchain: Hardware-Assisted Blockchain for Sustainable Simultaneous Device and Data Security in Internet of Everything (IoE)", *IEEE Consumer Electronics Magazine (MCE)*, Vol. 9, No. 2, March 2020, pp. 8-16.

# PUFchain – The Big Idea

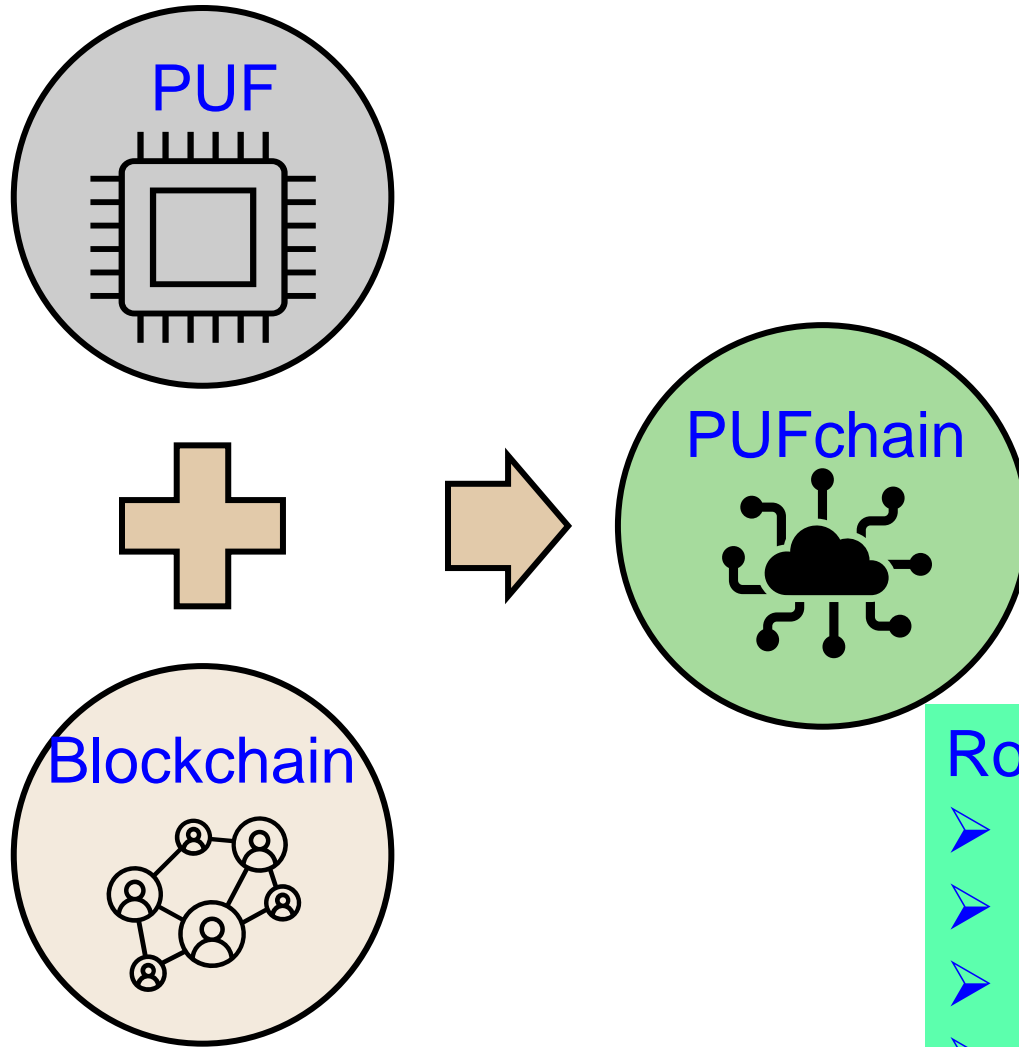

Blockchain Technology is integrated with Physically Unclonable Functions as PUFchain by storing the PUF Key into immutable Blockchain

## Roles of PUF:

- Hardware Accelerator for Blockchain
- Independent Authentication
- Double-Layer Protection
- 3 modes: PUF, Blockchain, PUF+Blockchain



# Our PUFchain – 3 Variants

Research Works	Distributed Ledger Technology	Focus Area	Security Approach	Security Primitive	Security Principle
PUFchain	Blockchain	IoT / CPS (Device and Data)	Proof of Physical Unclonable Function (PUF) Enabled Authentication	PUF + Blockchain	Hardware Assisted Security (HAS) or Security-by-Design (SbD)
PUFchain 2.0	Blockchain	IoT/CPS (Device and Data)	Media Access Control (MAC) & PUF Based Authentication	PUF + Blockchain	Hardware Assisted Security (HAS) or Security-by-Design (SbD)
PUFchain 3.0	Tangle	IoT/CPS (Device and Data)	Masked Authentication Messaging (MAM)	PUF + Tangle	Hardware Assisted Security (HAS) or Security-by-Design (SbD)



# PUFchain: Our Hardware-Assisted Scalable Blockchain

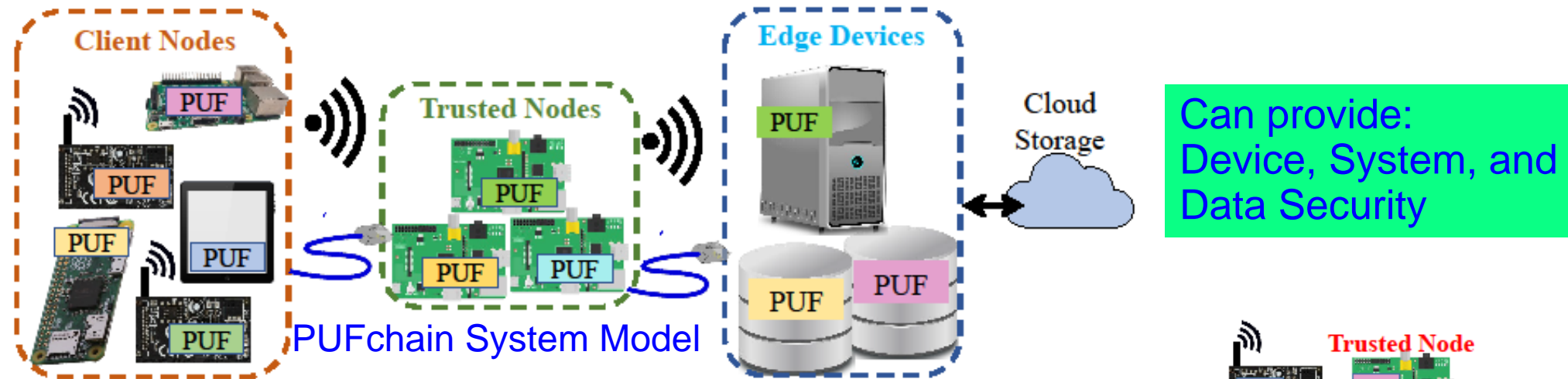

Can provide:  
Device, System, and  
Data Security

PUFChain 2 Modes:  
(1) PUF Mode and  
(2) PUFChain Mode

- ✓ PoP is 1,000X faster than PoW
- ✓ PoP is 5X faster than PoAh

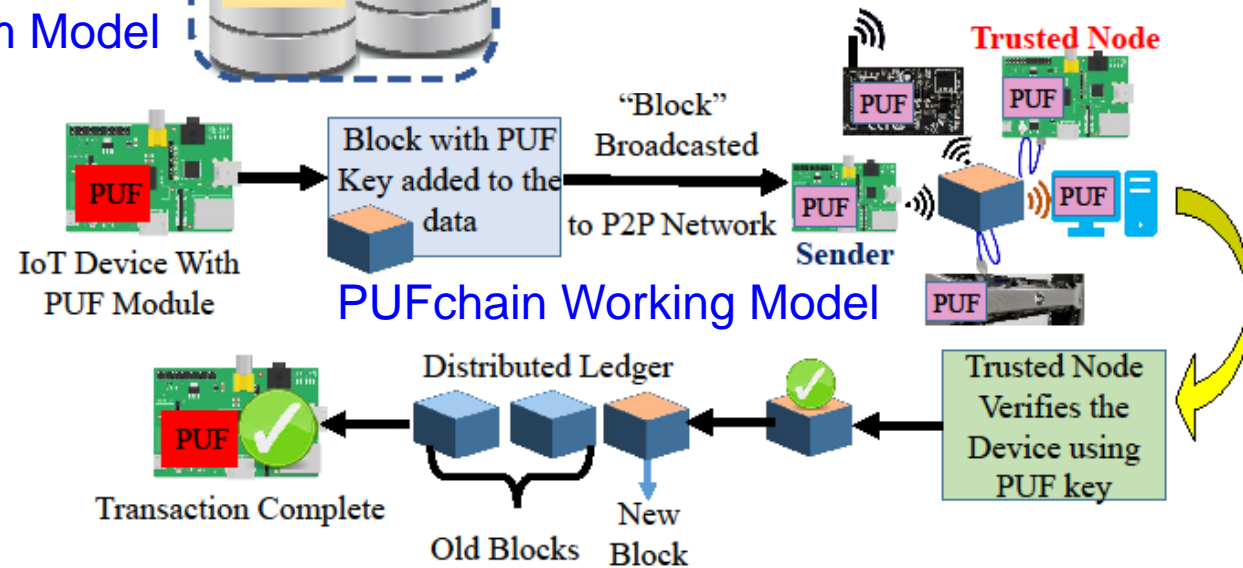

Source: S. P. Mohanty, V. P. Yanambaka, E. Kougianos, and D. Puthal, "PUFchain: Hardware-Assisted Blockchain for Sustainable Simultaneous Device and Data Security in Internet of Everything (IoE)", *IEEE Consumer Electronics Magazine (MCE)*, Vol. 9, No. 2, March 2020, pp. 8-16.

# Our Proof-of-PUF-Enabled-Authentication (PoP)

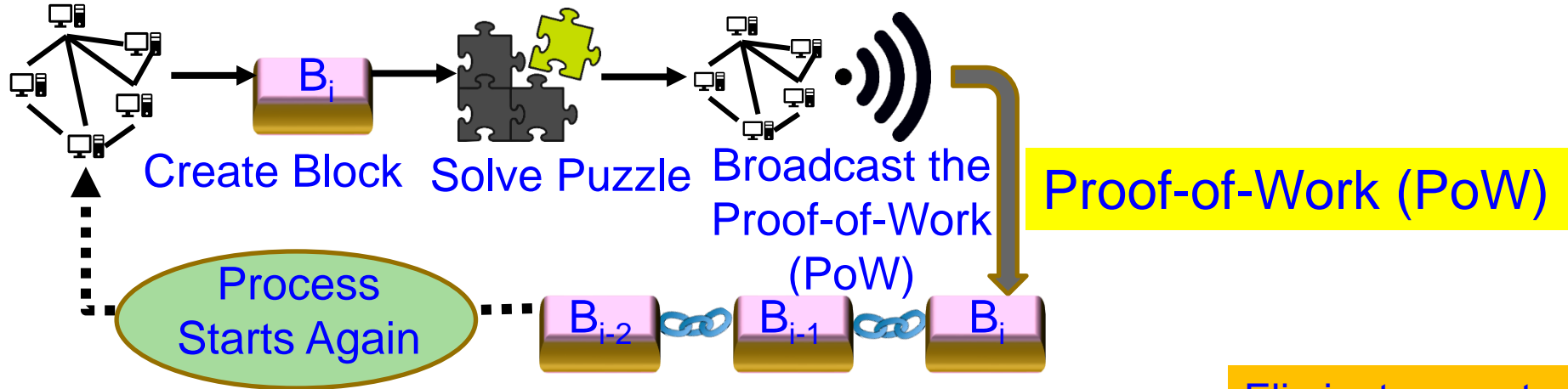

Eliminates cryptographic “puzzle” solving to validate blocks.

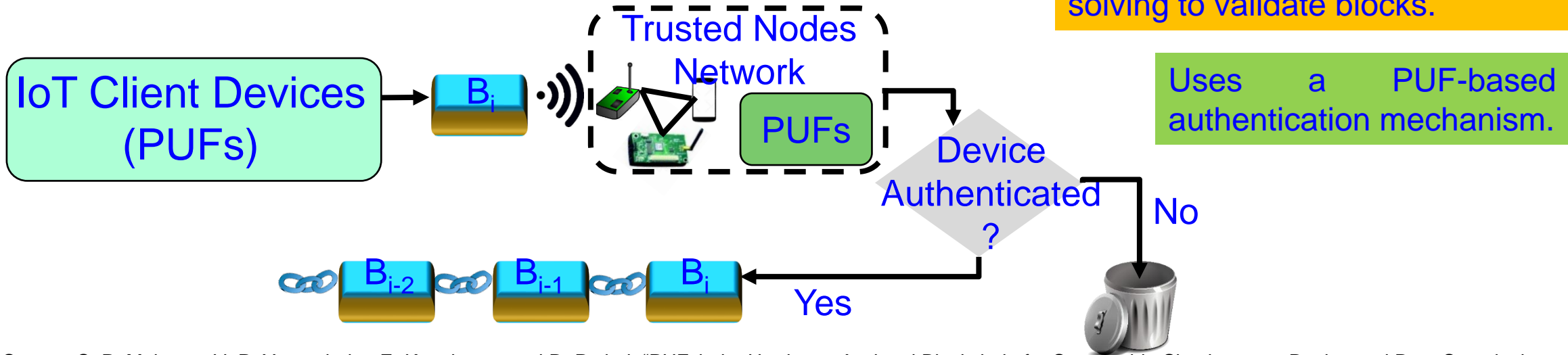

Source: S. P. Mohanty, V. P. Yanambaka, E. Kougianos, and D. Puthal, “PUFchain: Hardware-Assisted Blockchain for Sustainable Simultaneous Device and Data Security in Internet of Everything (IoE)”, *IEEE Consumer Electronics Magazine (MCE)*, Vol. 9, No. 2, March 2020, pp. 8-16.

# PUFchain: Our PoP is 1000X Faster than PoW

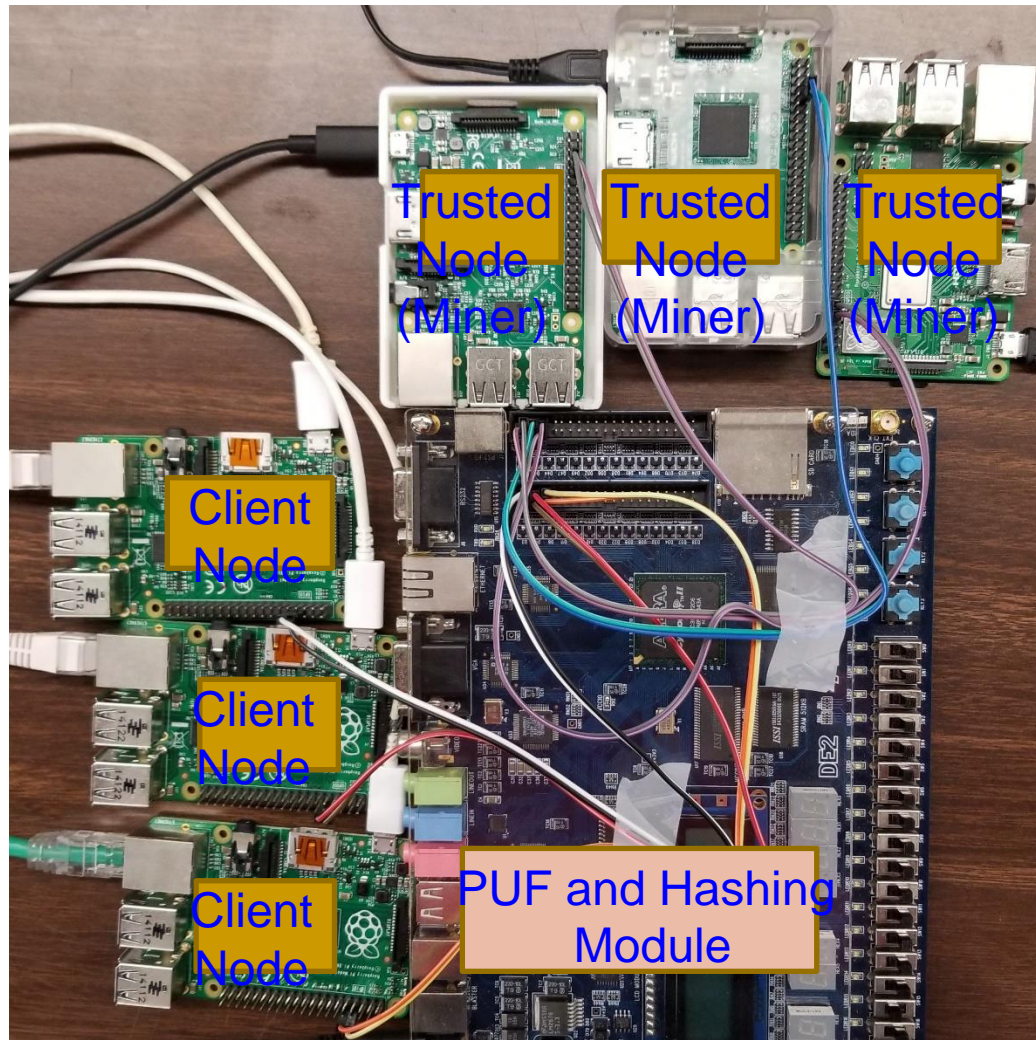

PoW - 10  
min in cloud

PoAh – 950ms  
in Raspberry Pi

PoP - 192ms  
in Raspberry Pi

High Power

3 W Power

5 W Power

- ✓ PoP is 1,000X faster than PoW
- ✓ PoP is 5X faster than PoAh

Source: S. P. Mohanty, V. P. Yanambaka, E. Kougianos, and D. Puthal, "PUFchain: Hardware-Assisted Blockchain for Sustainable Simultaneous Device and Data Security in Internet of Everything (IoE)", *IEEE Consumer Electronics Magazine (MCE)*, Vol. 9, No. 2, March 2020, pp. 8-16.



# PUFchain 2.0: Our Hardware-Assisted Scalable Blockchain

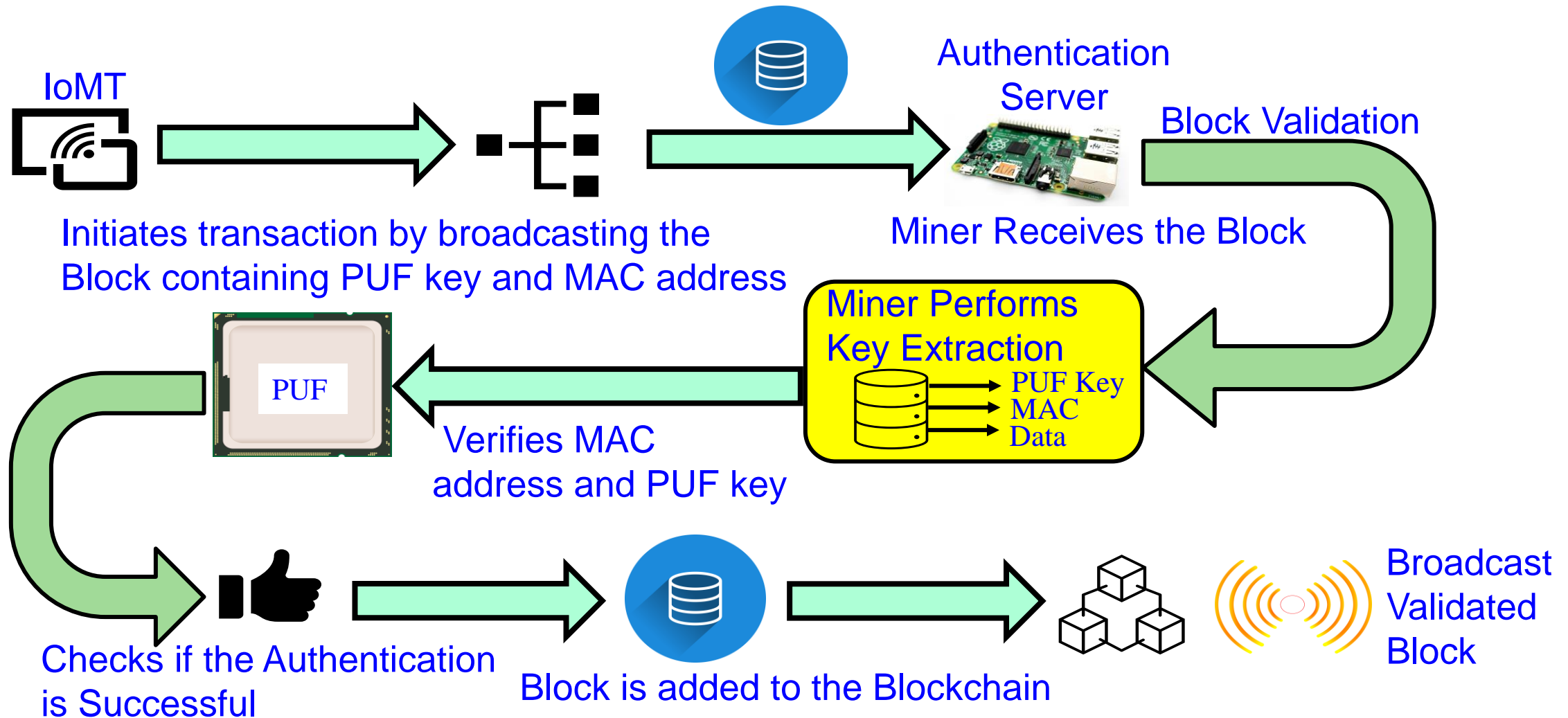

Source: V. K. V. V. Bathalapalli, **S. P. Mohanty**, E. Kougianos, B. K. Baniya, and B. Rout, "PUFchain 2.0: Hardware-Assisted Robust Blockchain for Sustainable Simultaneous Device and Data Security in Smart Healthcare", *Springer Nature Computer Science (SN-CS)*, Vol. 3, No. 5, Sep 2022, Article: 344, 19-pages, DOI: <https://doi.org/10.1007/s42979-022-01238-2>.



# PUFchain 2.0: PUF Integrated Blockchain ...

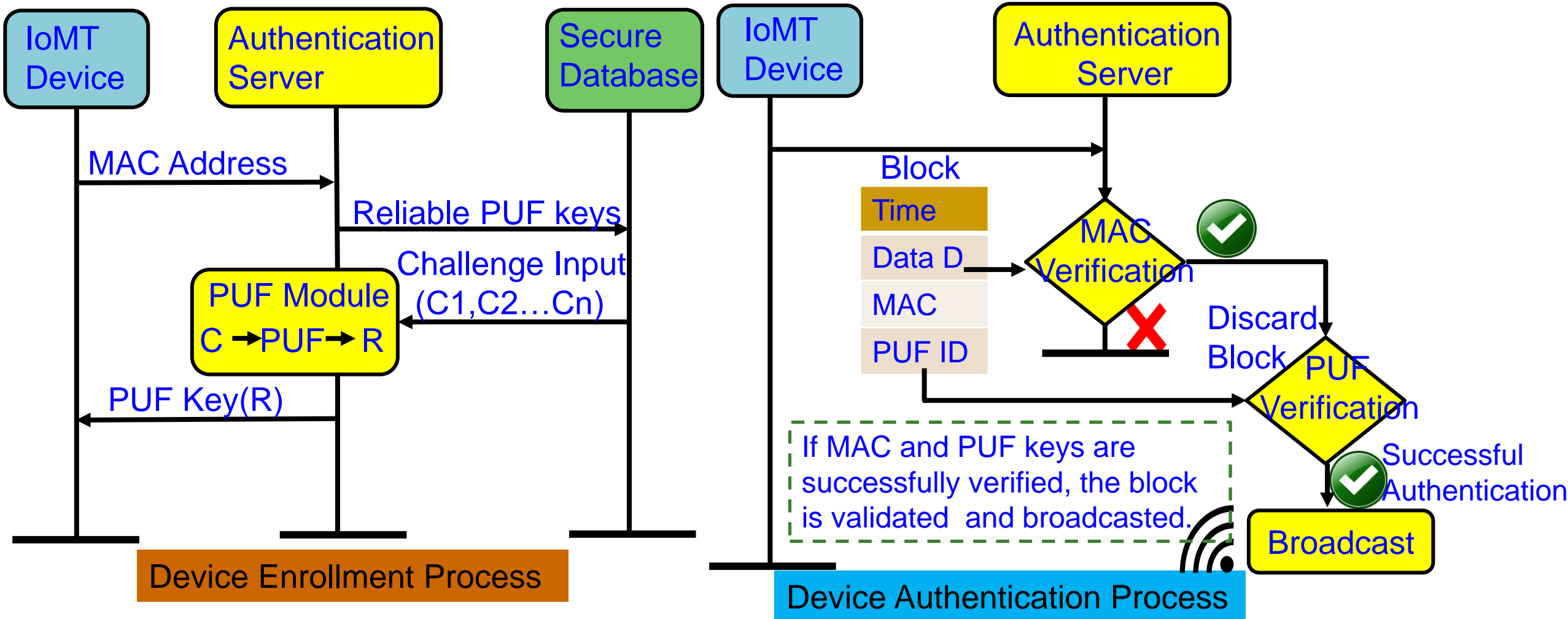

Source: V. K. V. V. Bathalapalli, **S. P. Mohanty**, E. Kougianos, B. K. Baniya, and B. Rout, "PUFchain 2.0: Hardware-Assisted Robust Blockchain for Sustainable Simultaneous Device and Data Security in Smart Healthcare", *Springer Nature Computer Science (SN-CS)*, Vol. 3, No. 5, Sep 2022, Article: 344, 19-pages, DOI: <https://doi.org/10.1007/s42979-022-01238-2>.

# PUFchain 3.0 - Conceptual Idea

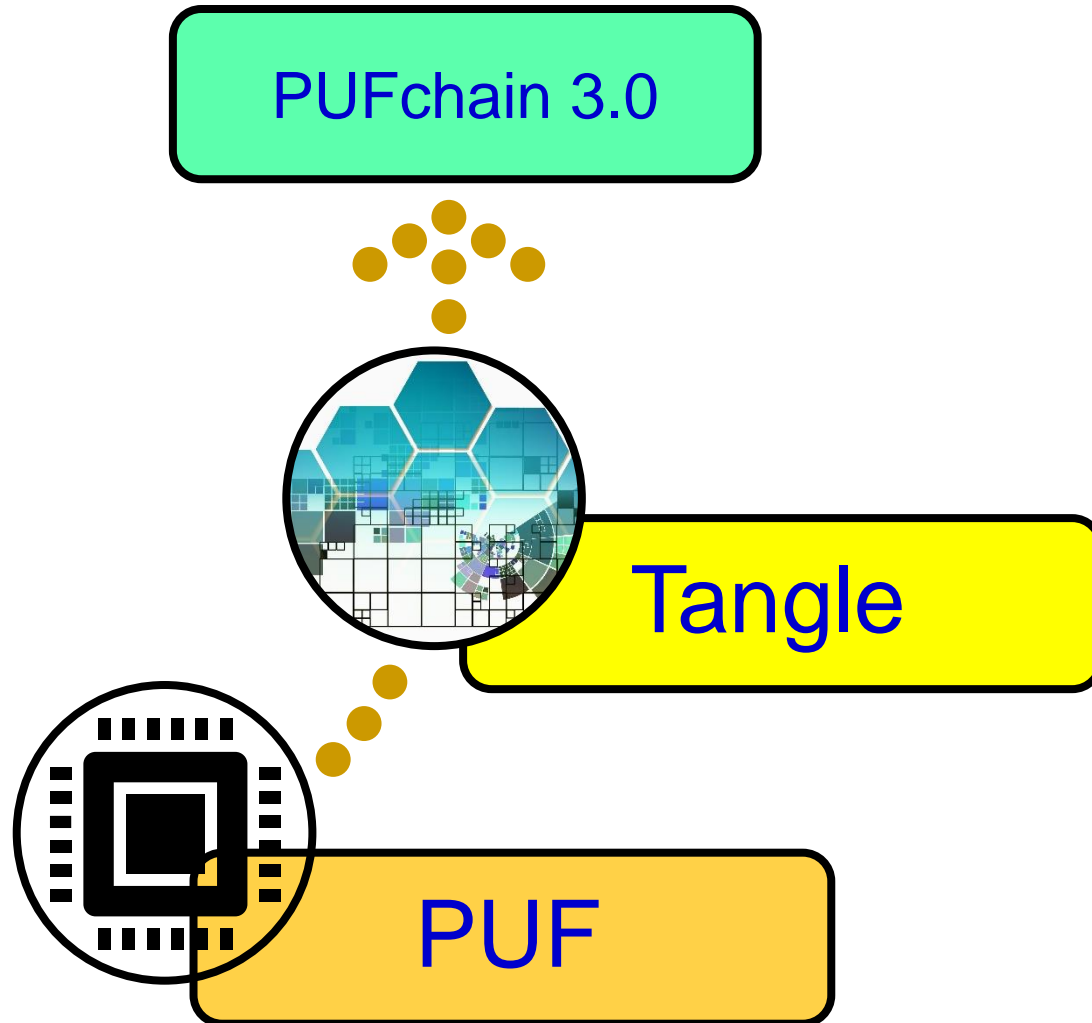

- PUFchain 3.0 is the idea of integrating PUF with scalable Tangle DLT using MAM communication protocol by creating a MAM communication channel in Tangle using PUF key

Source: V. K. V. V. Bathalapalli, **S. P. Mohanty**, E. Kougianos, B. K. Baniya, and B. Rout, "PUFchain 3.0: Hardware-Assisted Distributed Ledger for Robust Authentication in the Internet of Medical Things", in *Proceedings of IFIP International Internet of Things Conference (IFIP-IoT)*, 2022, pp. 23--40, DOI: [https://doi.org/10.1007/978-3-031-18872-5\\_2](https://doi.org/10.1007/978-3-031-18872-5_2).

# PUFchain 3.0 - Architecture

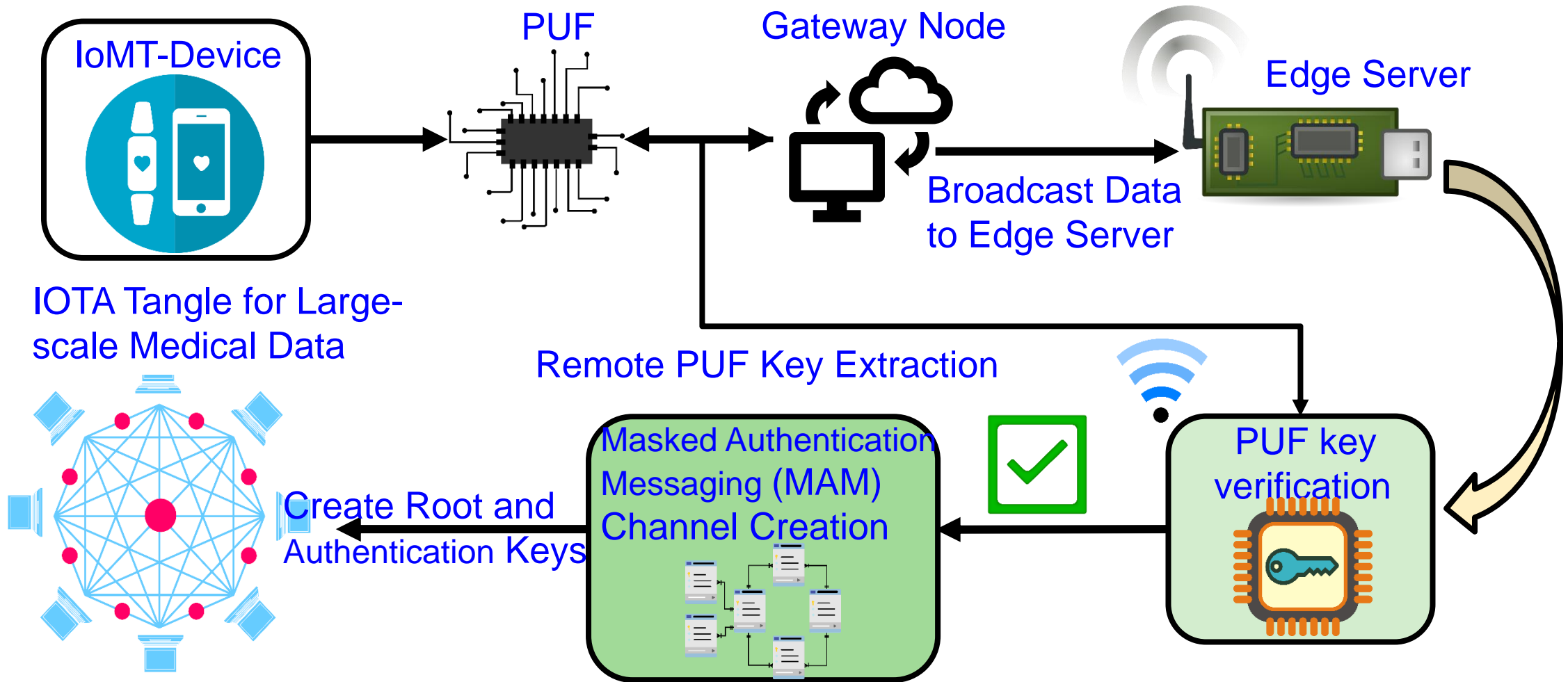

Source: V. K. V. V. Bathalapalli, **S. P. Mohanty**, E. Kougianos, B. K. Baniya, and B. Rout, "PUFchain 3.0: Hardware-Assisted Distributed Ledger for Robust Authentication in the Internet of Medical Things", in *Proceedings of IFIP International Internet of Things Conference (IFIP-IoT)*, 2022, pp. 23--40, DOI: [https://doi.org/10.1007/978-3-031-18872-5\\_2](https://doi.org/10.1007/978-3-031-18872-5_2).

# PUFchain 3.0: Comparative Analysis

Research Works	Application	DLT or Blockchain	Authentication Mechanism	Performance Metrics
<b>Mohanty et al. 2020 - PUFchain</b>	IoMT (Device and Data)	Blockchain	Proof-of-PUF-Enabled Authentication	PUF Design Uniqueness - 47.02%, Reliability-1.25%
Chaudhary et al. 2021 - Auto-PUFchain	Hawrdware Supply Chain	Blockchain	Smart Contracts	Gas Cost for Ethereum transaction 21.56 USD (5-Stage)
Al-Joboury et al. 2021 - PoQDB	IoT (Data)	Blockchain & Cobweb	IoT M2M Messaging (MQTT)	Transaction Time - 15 ms
Wang et al. 2022 - PUF-Based Authentication	IoMT (Device)	Blockchain	Smart Contracts	NA
Hellani et al. 2021- Tangle the Blockchain	IoT (Data)	Blockchain & Tangle	Smart Contracts	NA
<b>Bathalapalli et al. 2022-PUFchain 2.0</b>	IoMT (Device)	Blockchain	Media Access Control (MAC) & PUF based Authentication	Total On-Chip Power - 0.081 W, PUF Hamming Distance - 48.02 %
<b>Our PUFchain 3.0 in 2022</b>	<b>IoMT (Device)</b>	<b>Tangle</b>	<b>Masked Authentication Messaging</b>	<b>Authentication 2.72 sec, Reliability - 100% (Approx), MAM Mode-Restricted</b>

Source: V. K. V. V. Bathalapalli, **S. P. Mohanty**, E. Kougianos, B. K. Baniya, and B. Rout, “[PUFchain 3.0: Hardware-Assisted Distributed Ledger for Robust Authentication in the Internet of Medical Things](https://doi.org/10.1007/978-3-031-18872-5_2)”, in *Proceedings of IFIP International Internet of Things Conference (IFIP-IoT)*, 2022, pp. 23--40, DOI: [https://doi.org/10.1007/978-3-031-18872-5\\_2](https://doi.org/10.1007/978-3-031-18872-5_2).



---

# Smart Healthcare – Trustworthy Pharmaceutical Supply Chain

# Fake Medicine - Serious Global Issue

- It is estimated that close to \$83 billion worth of counterfeit drugs are sold annually.
- One in 10 medical products circulating in developing countries are substandard or fake.
- In Africa: Counterfeit antimalarial drugs results in more than 120,000 deaths each year.
- USA has a closed drug distribution system intended to prevent counterfeits from entering U.S. markets, but it isn't foolproof due to many reason including illegal online pharmacy.

Source: <https://fraud.org/fakerx/fake-drugs-and-their-risks/counterfeit-drugs-are-a-global-problem/>



Source: <https://allaboutpharmacovigilance.org/be-aware-of-counterfeit-medicine/>

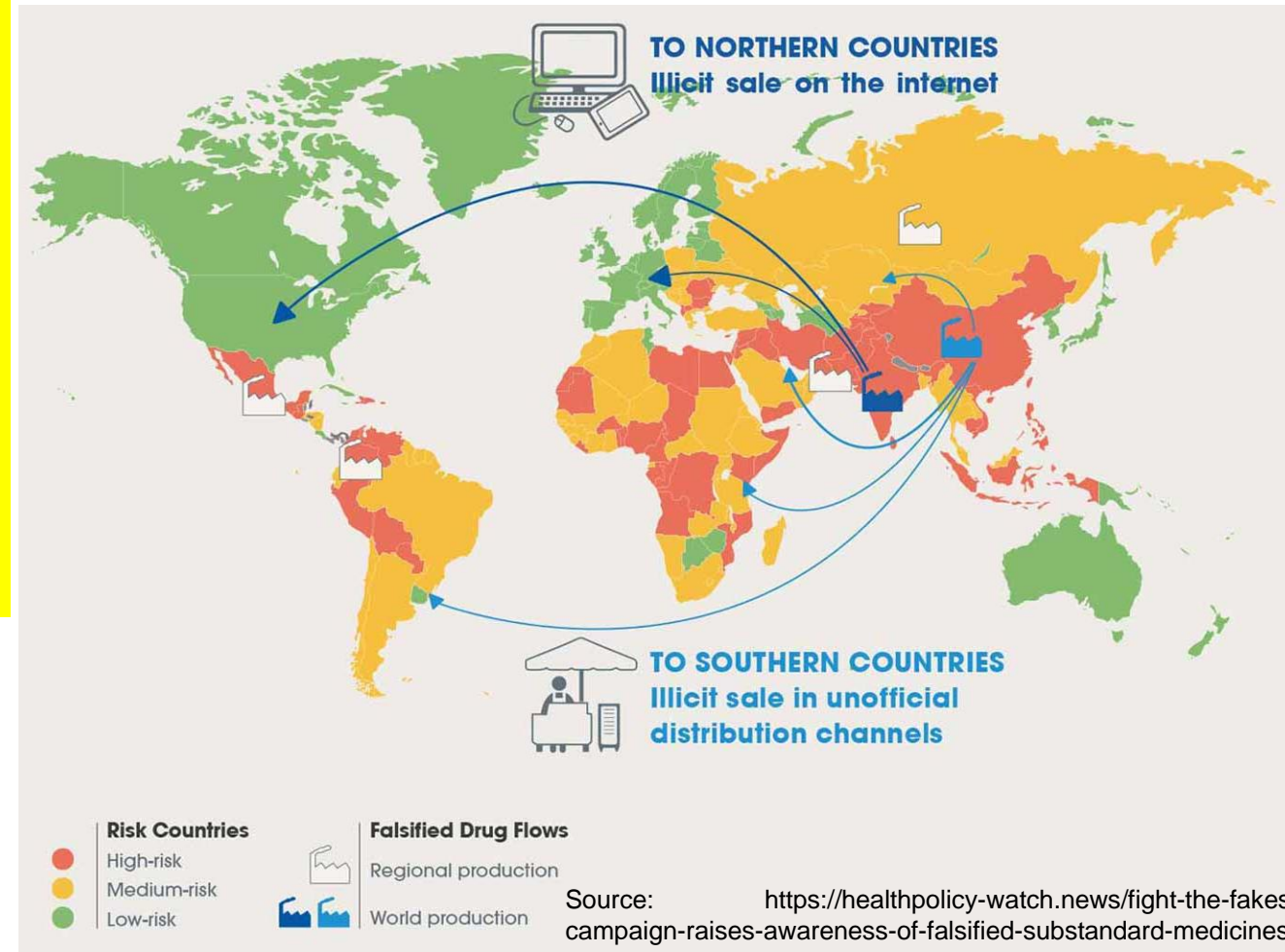

# PharmaChain - Counterfeit Free Pharmaceutical

## Enterprise Resource Planning

### Transaction Ledger

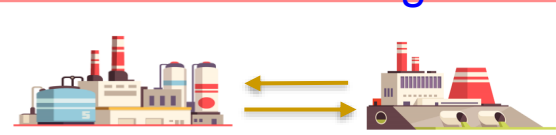

### Blind Parties



Manufacturer places order and ingredients are supplied

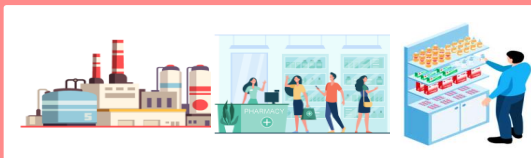
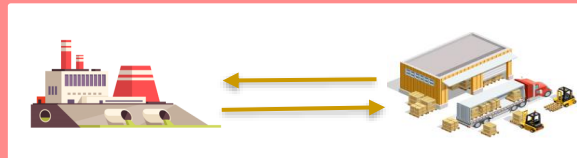

### Wholesaler places order from Manufacturer

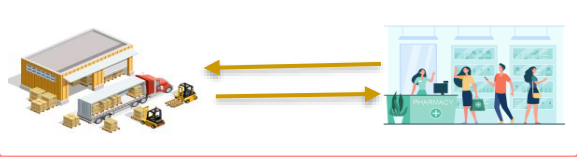

### Transfer of drugs from wholesaler to pharmacy

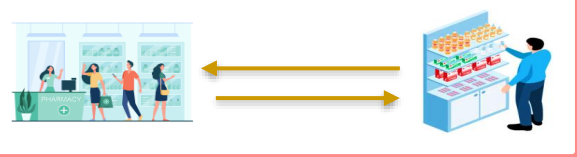

Prescribed medicines are dispensed to the consumer

## Blockchain System

### Blockchain Ledger

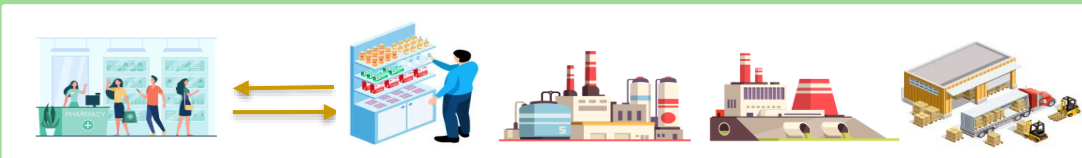

Transparent Ledger

Ingredients

Manufacturer

Wholesaler

Consumer

Pharmacy

Source: A. K. Bapatla, **S. P. Mohanty**, E. Kougianos, D. Puthal, and A. Bapatla, "PharmaChain: A Blockchain to Ensure Counterfeit-Free Pharmaceutical Supply Chain", *IET Networks*, Vol. XX, No. YY, ZZ 2022, pp. Accepted on 24 June 2022, DOI: <https://doi.org/10.1049/ntw2.12041>. (Dataset for Research: GitHub)

# Architectural Overview of PharmaChain

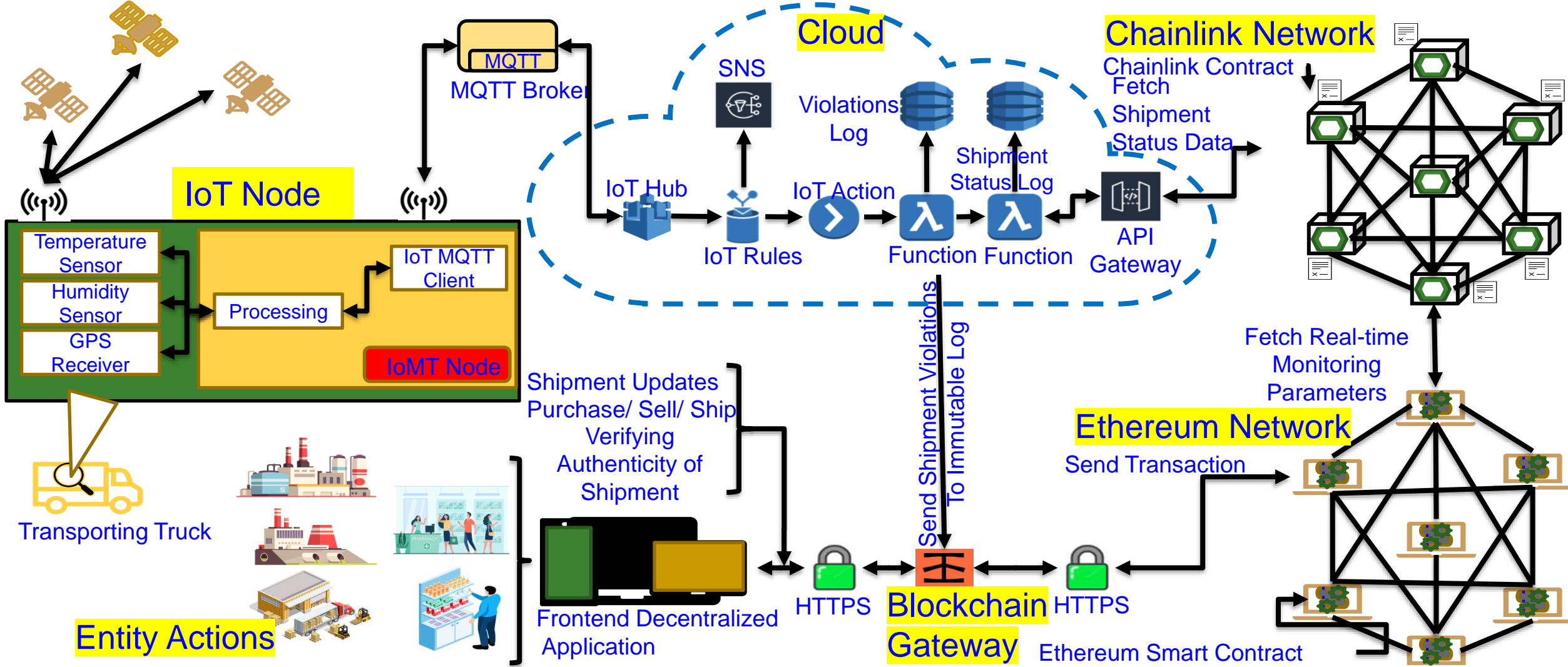

Source: A. K. Bapatla, **S. P. Mohanty**, E. Kougianos, D. Puthal, and A. Bapatla, "PharmaChain: A Blockchain to Ensure Counterfeit-Free Pharmaceutical Supply Chain", *IET Networks*, Vol. XX, No. YY, ZZ 2022, pp. Accepted on 24 June 2022, DOI: <https://doi.org/10.1049/ntw2.12041>. (Dataset for Research: [GitHub](#))



# PharmaChain Entity Diagram

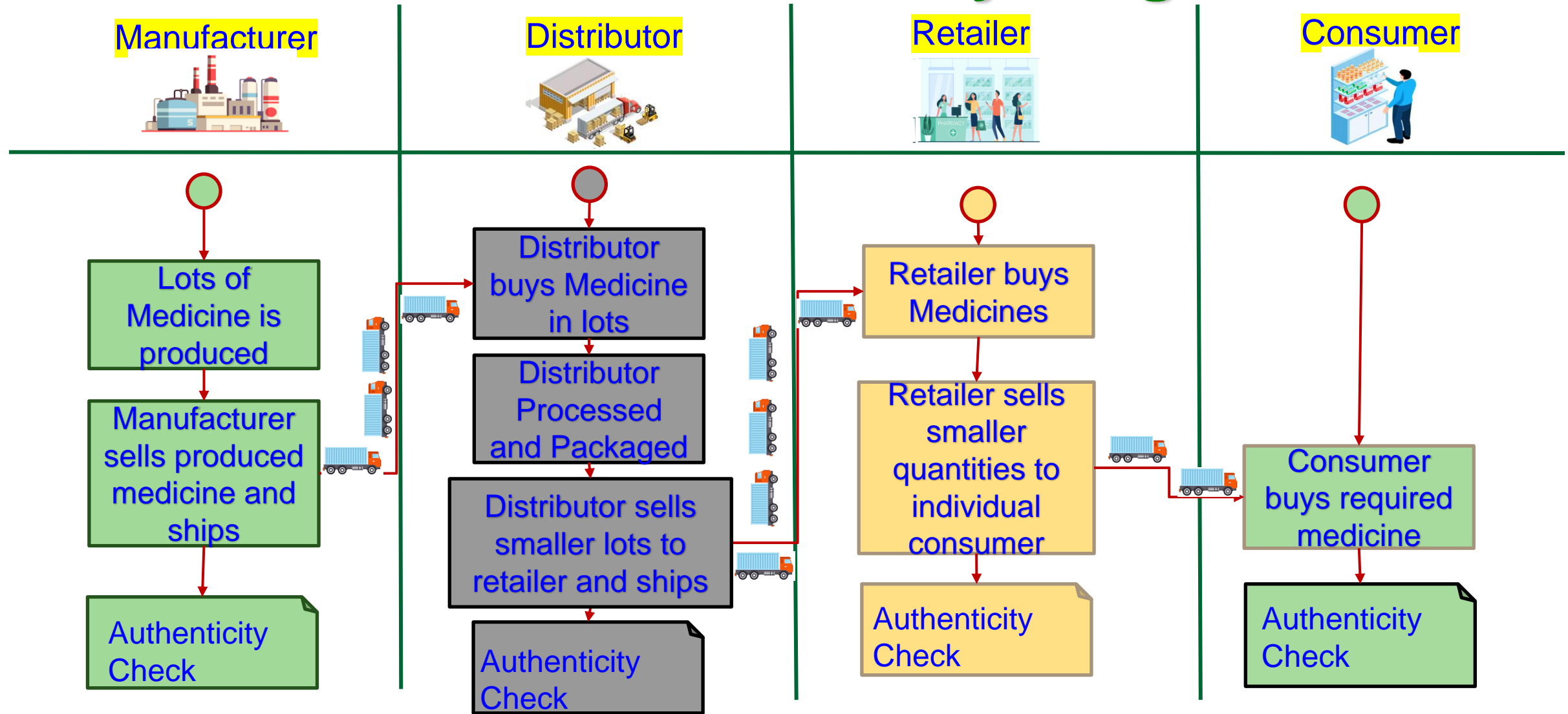

Source: Bapatla, A.K., et al.: PharmaChain: a blockchain to ensure counterfeit-free pharmaceutical supply chain. IET Netw. 1– 24 (2022). <https://doi.org/10.1049/ntw2.12041>

# PharmaChain 2.0 - Architecture Overview

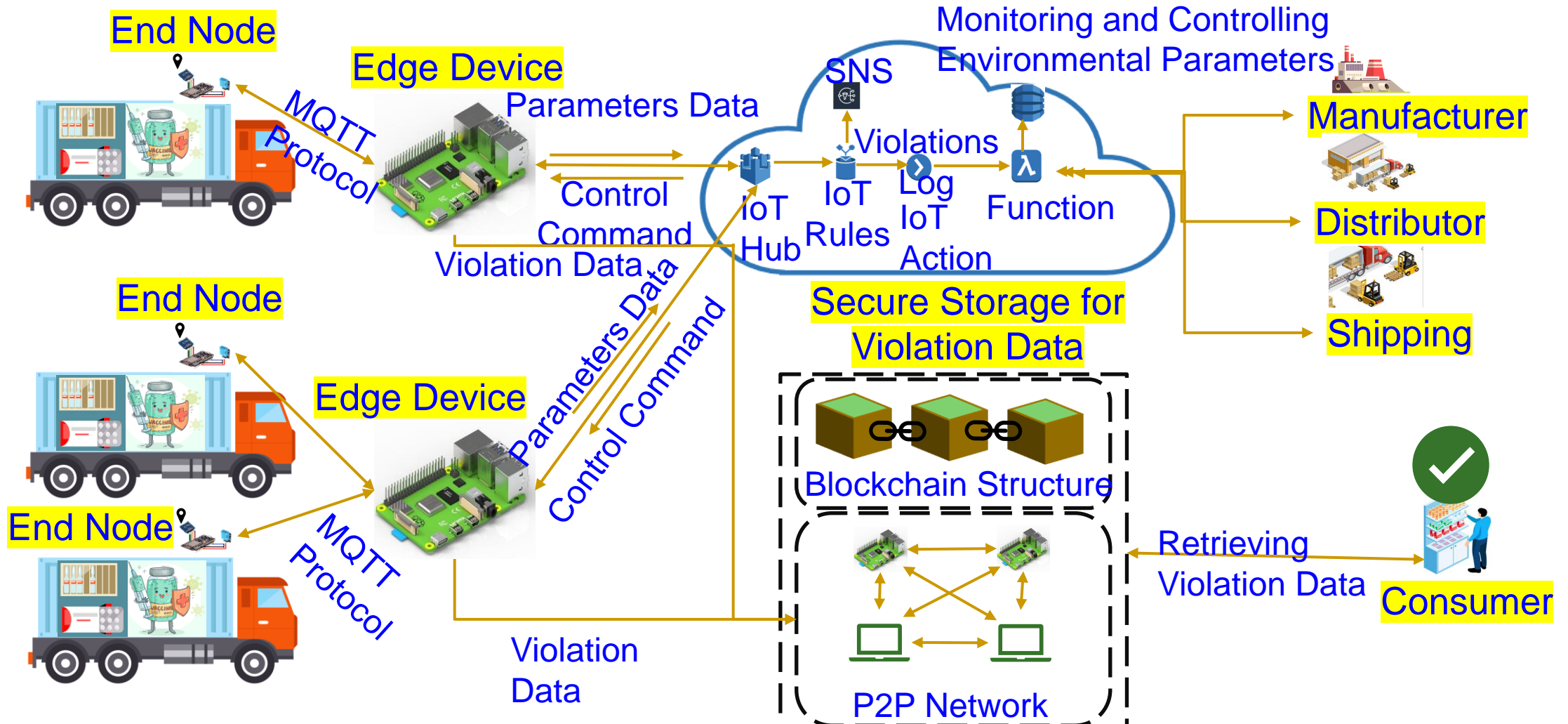

Source: A. K. Bapatla, **S. P. Mohanty**, E. Kougianos, and D. Puthal, "PharmaChain 2.0: A Blockchain Framework for Secure Remote Monitoring of Drug Environmental Parameters in Pharmaceutical Cold Supply Chain", in *Proceedings of the IEEE International Symposium on Smart Electronic Systems (iSES)*, 2022, pp. Accepted.

# PharmaChain Versus PharmaChain 2.0

PharmaChain	PharmaChain 2.0
Tracking and Tracing in Pharmaceutical Supply Chain	Both Tracking & Tracing along with Monitoring and Controlling Temperature Excursions
Ethereum Blockchain	PoAh Consensus Based Blockchain (our EasyChain)
Proof-of-Authority (PoA) with less throughput compared to PoAh	Proof-of-Authentication (PoAh) with higher throughput
Private Blockchain with only nodes participating from Entities	Private Blockchain with only nodes participating from Entities
Not IoT friendly Consensus	IoT Friendly Consensus with less power and computations
Average transaction processing time is 5.6 sec.	Average transaction time has been improved significantly to 322.28 ms

# PharmaChain 3.0 - Architectural Overview

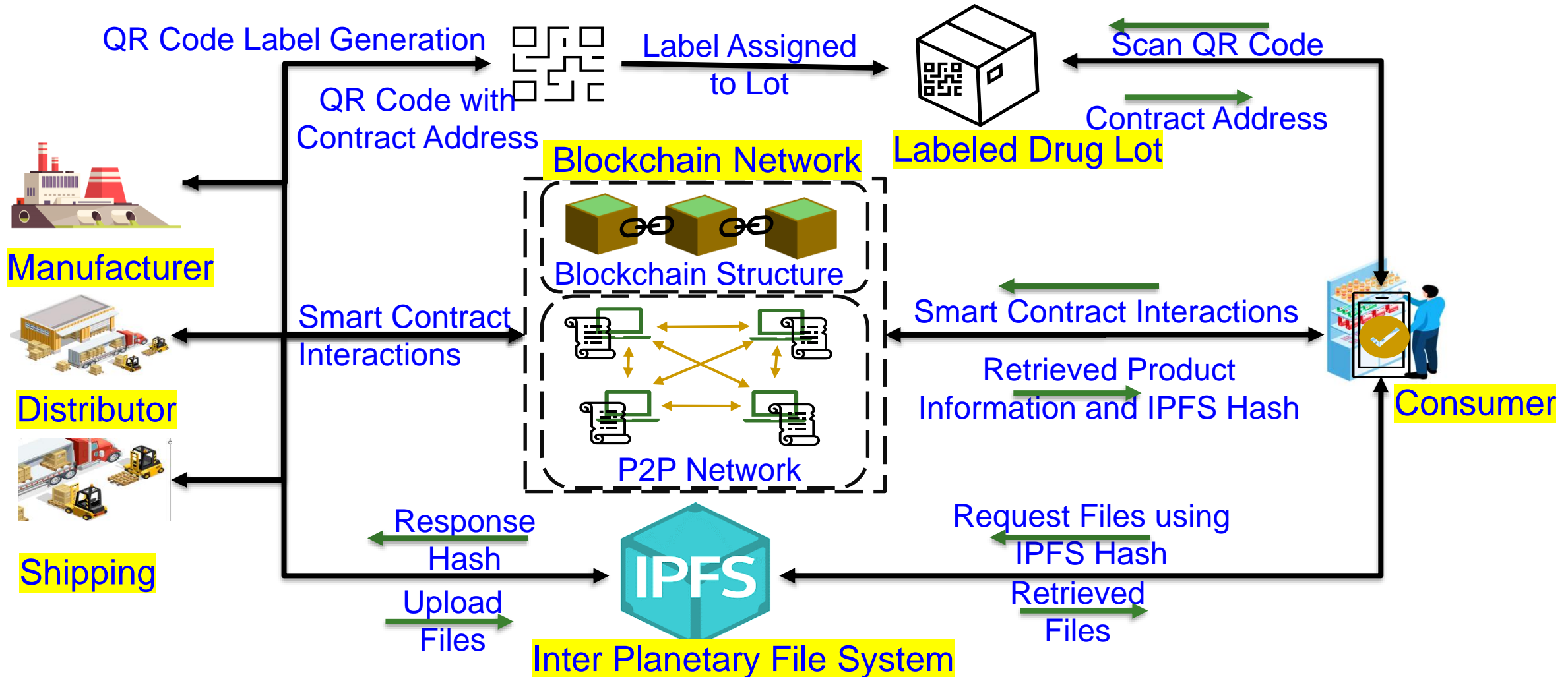

Source: A. K. Bapatla, S. P. Mohanty, E. Kougianos, and D. Puthal, "PharmaChain 3.0: Blockchain Integrated Efficient QR Code Mechanism for Pharmaceutical Supply Chain", in *Proceedings of the OITS International Conference on Information Technology (OCIT)*, 2022, pp. Accepted.



# PharmaChain 2.0 Versus PharmaChain 3.0

PharmaChain 2.0	PharmaChain 3.0
Both <b>Tracking &amp; Tracing</b> along with <b>Monitoring and Controlling</b> Temperature Excursions	Integrating <b>QR Code Mechanism</b> for easy <b>Tracking and Tracing</b> and <b>Drug Information</b>
PoAh Consensus Based Blockchain (Our <b>EasyChain</b> )	<b>Ethereum</b> Blockchain into the CPS
Proof-of-Authentication (PoAh) with <b>higher throughput</b>	Proof-of-Stake (PoS) Consensus mechanism is used with <b>lesser throughput than PoAh</b>
<b>Private Blockchain</b> with only nodes participating from Entities	<b>Private Blockchain</b> with only nodes participating from Entities
<b>IoT Friendly</b> Consensus with less power and computations. <b>Doesn't</b> support <b>smart Contracts</b> .	P2P nodes are maintained by the entities and are computationally capable. <b>No need for IoT-Friendly Consensus</b>
The average transaction time is <b>322.28ms</b>	The average Transaction time is <b>16.2 Sec</b>
<b>Less information</b> storage capabilities	<b>More information</b> can be stored

# PharmaChain 3.0 - Comparative Analysis

Works	Blockchain	Consensus Mechanism	Computational Needs	Openness	QR Code Integrated	Storage	Handling Large data
Crypto Cargo [11]	Ethereum	Proof-of-Work (PoW)	High	Public	No	On-Chain and Cloud	No
Kumar et.al. [9]	NA	NA	NA	NA	Yes	On-chain	No
PharmaChain [12]	Ethereum	Proof-of-Authority (PoA)	Low	Private	No	On-Chain and Cloud	No
PharmaChain 2.0	Our EasyChain	Proof-of-Authentication (PoAh)	Low	Private	No	On-Chain and Cloud	No
Current Solution (PharmaChain 3.0)	Ethereum	Proof-of-Stake (PoS)	Low	Private	Yes	On-Chain and off-Chain	Yes

---

# Is Physical Unclonable Function (PUF) the Solution for Every Cybersecurity Problem?

# If PUF is So Great, Why Isn't Everyone Using It?

- PUF technology is difficult to implement well.
- In addition to security system expertise, one needs analog circuit expertise to harness the minute variances in silicon and do it reliably.
- Some PUF implementations plan for a certain amount of marginality in the analog designs, so they create a PUF field of 256 bits (for example), knowing that only 50 percent of those PUF features might produce reliable bits, then mark which features are used on each production part.
- PUF technology relies on such minor variances, long-term quality can be a concern: will a PUF bit flip given the stresses of time, temperature, and other environmental factors?
- Overall the unique mix of security, analog expertise, and quality control is a formidable challenge to implementing a good PUF technology.

Source: <https://embeddedcomputing.com/technology/processing/semiconductor-ip/demystifying-the-physically-unclonable-function-puf>



# PUF Limitations – Larger Key Needs Large ICs

- Larger key requires larger chip circuit.

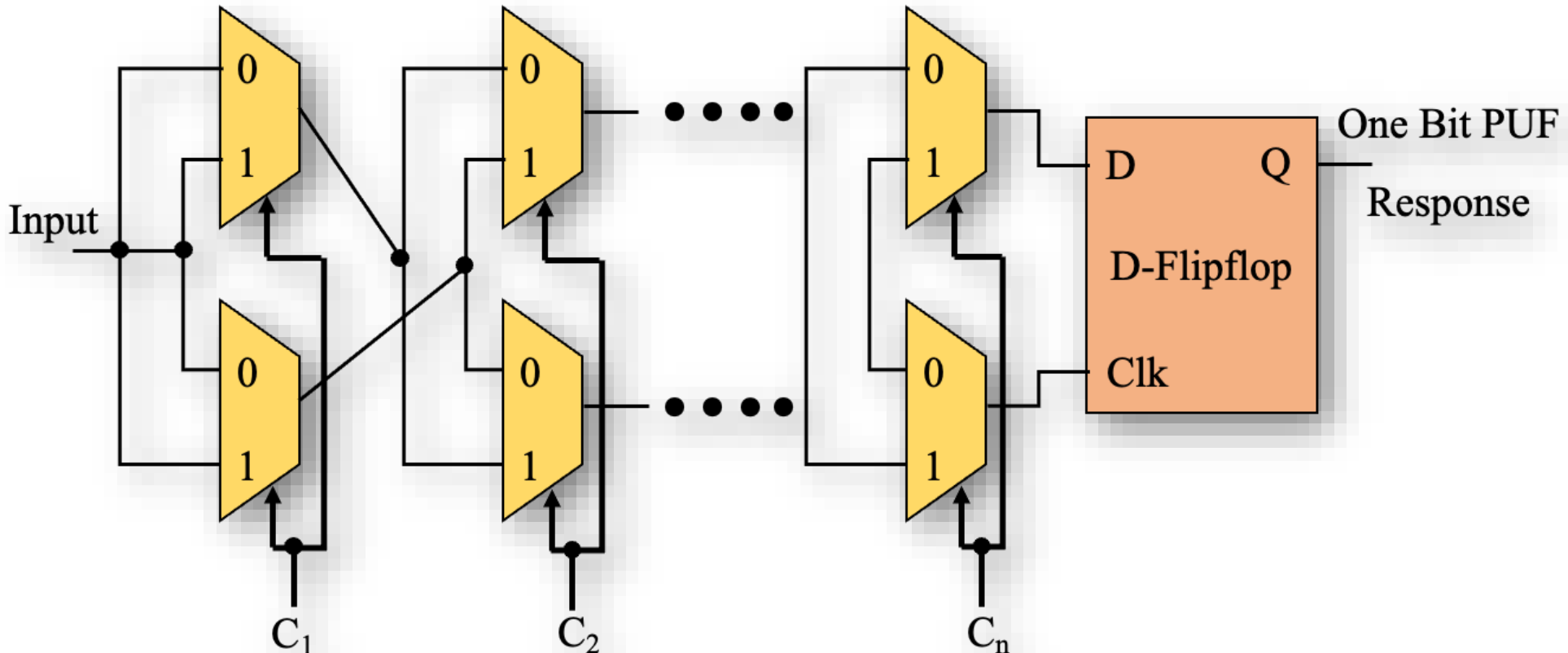

1 – Bit Arbiter PUF Architecture

# IC for PUF – Contradictory Design Objective - Variability versus Variability-Aware Design

Variability → Randomness for PUF

Manufacturing Variations  
(e.g. Oxide Growth, Ion  
Implantation, Lithography)

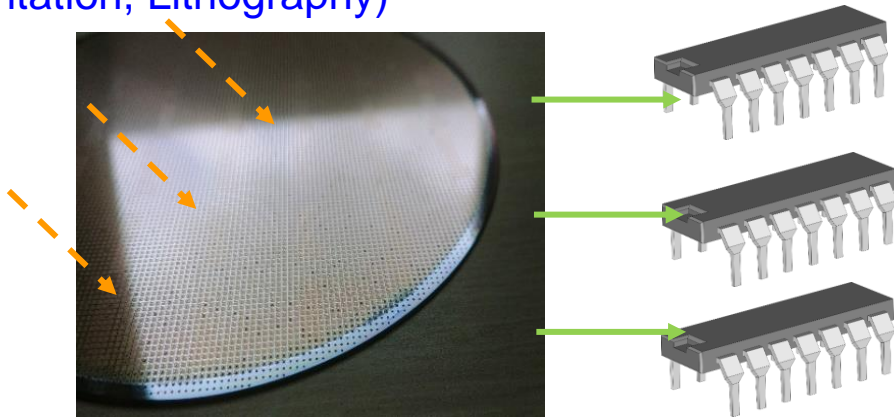

Variability-Aware Design →  
Robust Hardware

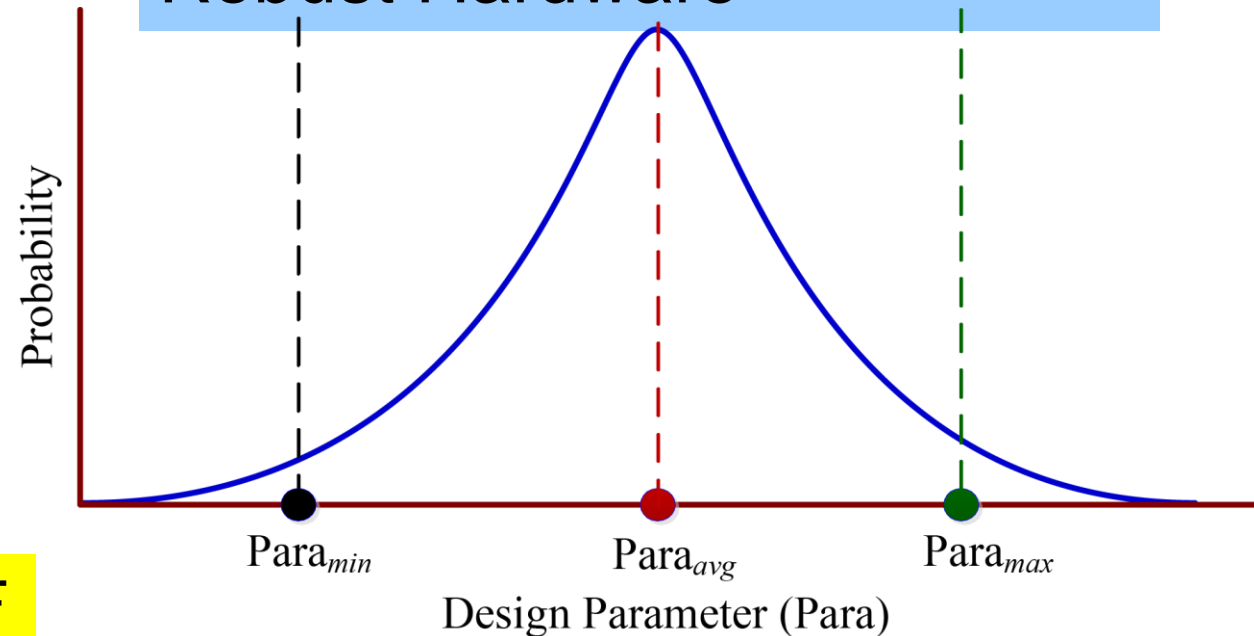

Variability Features → Randomness → PUF

Is it not case of Conflicting Objectives?  
How to have a Robust-IC design that functions as a PUF?

Optimize  $(\mu+n\sigma)$  to reduce  
variability for Robust Design



# PUF – FPGA versus IC

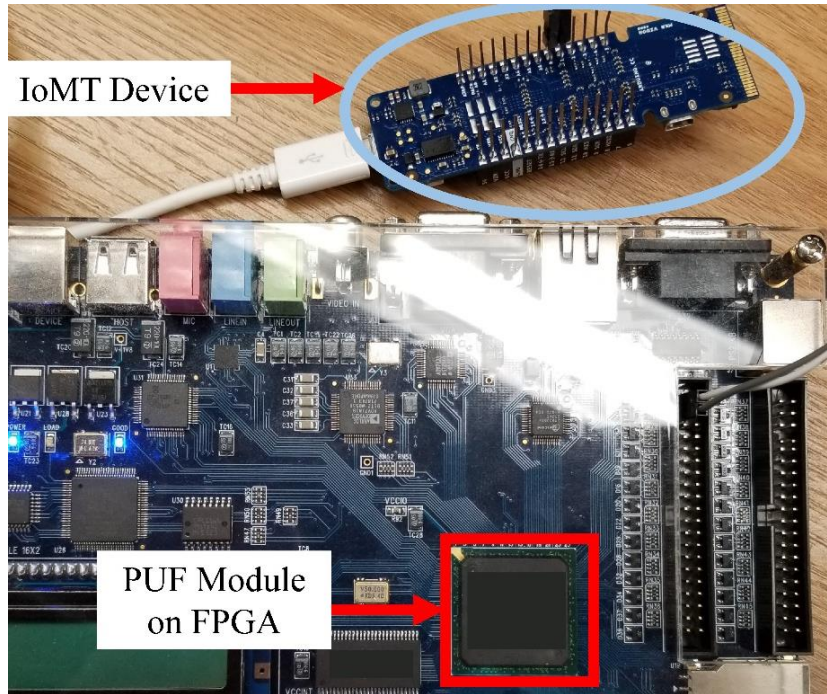

Source: V. P. Yanambaka, **S. P. Mohanty**, E. Kougianos, and D. Puthal, “[PMsec: Physical Unclonable Function-Based Robust and Lightweight Authentication in the Internet of Medical Things](#)”, *IEEE Transactions on Consumer Electronics (TCE)*, Volume 65, Issue 3, August 2019, pp. 388--397.

- Faster prototyping
- Lesser design effort
- Minimal skills
- Cheap
- Rely on already existing post fabrication variability



Source: **S. P. Mohanty** and E. Kougianos, “[Incorporating Manufacturing Process Variation Awareness in Fast Design Optimization of Nanoscale CMOS VCOs](#)”, *IEEE Transactions on Semiconductor Manufacturing (TSM)*, Volume 27, Issue 1, February 2014, pp. 22--31.

- Takes time to get it from fab
- More design effort
- Needs analog design skills
- Can be expensive
- Choice to send to fab as per the need

# PUF - Side Channel Leakage

- Delay-based PUF implementations are vulnerable to side-channel attacks.

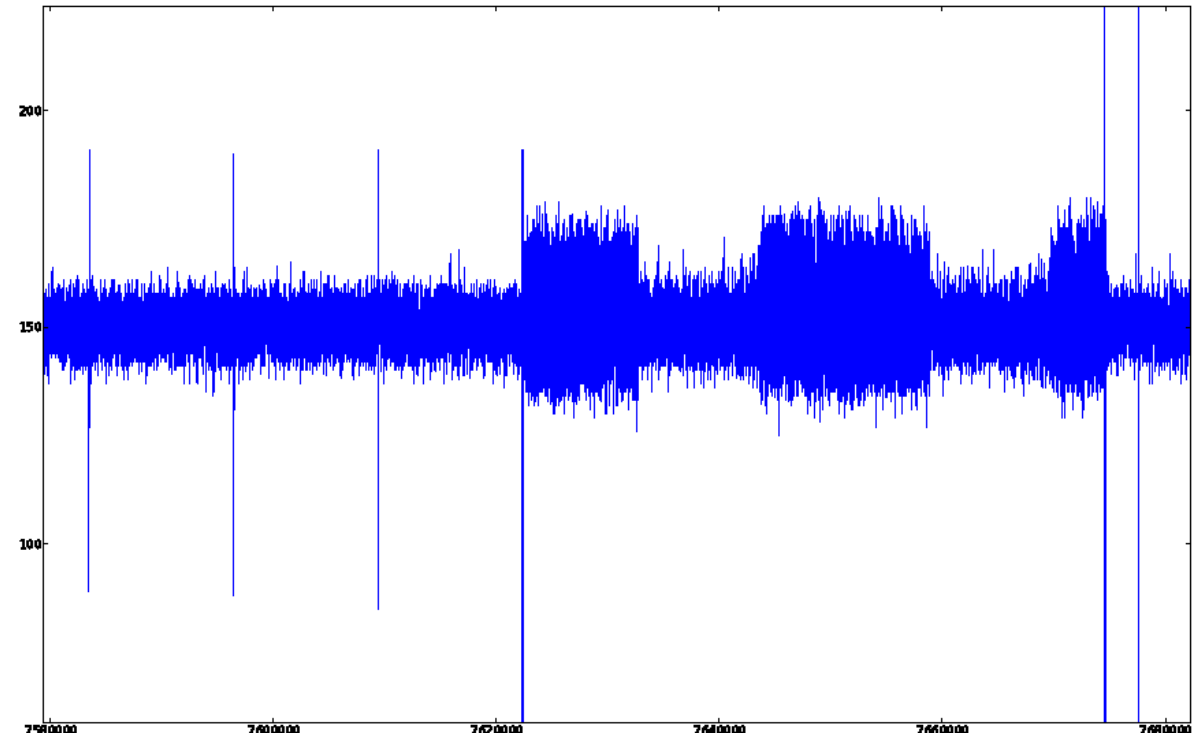
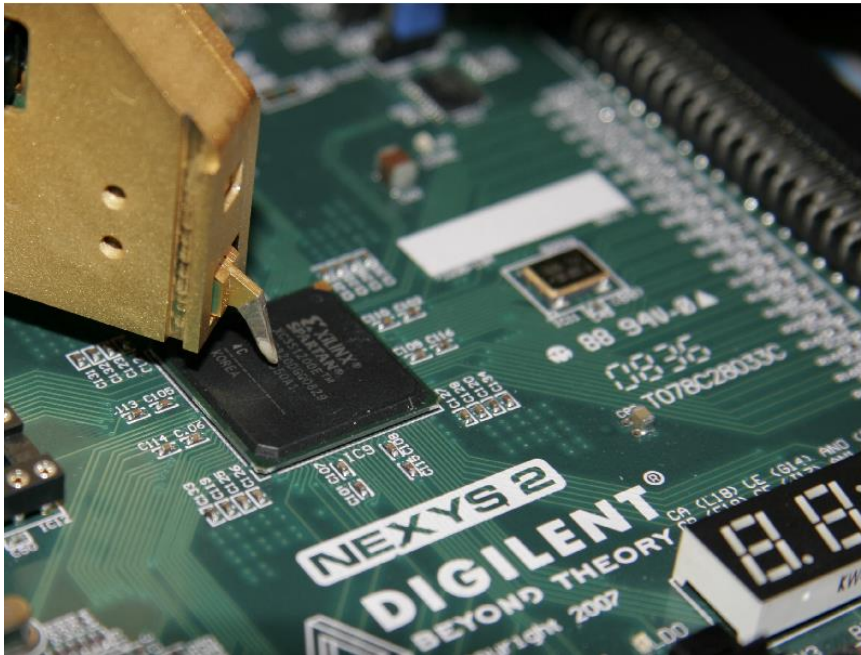

Langer ICR HH 150 probe over Xilinx Spartan3E-1200 FPGA

Source: Merli, D., Schuster, D., Stumpf, F., Sigl, G. (2011). Side-Channel Analysis of PUFs and Fuzzy Extractors. In: McCune, J.M., Balacheff, B., Perrig, A., Sadeghi, AR., Sasse, A., Beres, Y. (eds) Trust and Trustworthy Computing. Trust 2011. Lecture Notes in Computer Science, vol 6740. Springer, Berlin, Heidelberg. [https://doi.org/10.1007/978-3-642-21599-5\\_3](https://doi.org/10.1007/978-3-642-21599-5_3)

Magnification of the last part of the complete trace. Three trigger signals can be identified: (1) between oscillator phase and error correction phase, (2) between error correction and hashing, and (3) at the end of hashing.



# PUF – Trojan Issue

- Improper implementation of PUF could introduce "backdoors" to an otherwise secure system.
- PUF introduces more entry points for hacking into a cryptographic system.



Provide backdoor to adversary.  
Chip fails during critical needs.

Source: Rührmair, Ulrich; van Dijk, Marten (2013). *PUFs in Security Protocols: Attack Models and Security Evaluations* (PDF), in *Proc. IEEE Symposium on Security and Privacy*, May 19–22, 2013

# PUF – Machine Learning Attack

- One types of non-invasive attacks is machine learning (ML) attacks.
- ML attacks are possible for PUFs as the pre- and post-processing methods ignore the effect of correlations between PUF outputs.
- Many ML algorithms are available against known families of PUFs.

Source: Ganji, Fatemeh (2018), "On the learnability of physically unclonable functions", Springer. ISBN 978-3-319-76716-1.

# PUF based Cybersecurity in Smart Healthcare - Doctor's Dilemma

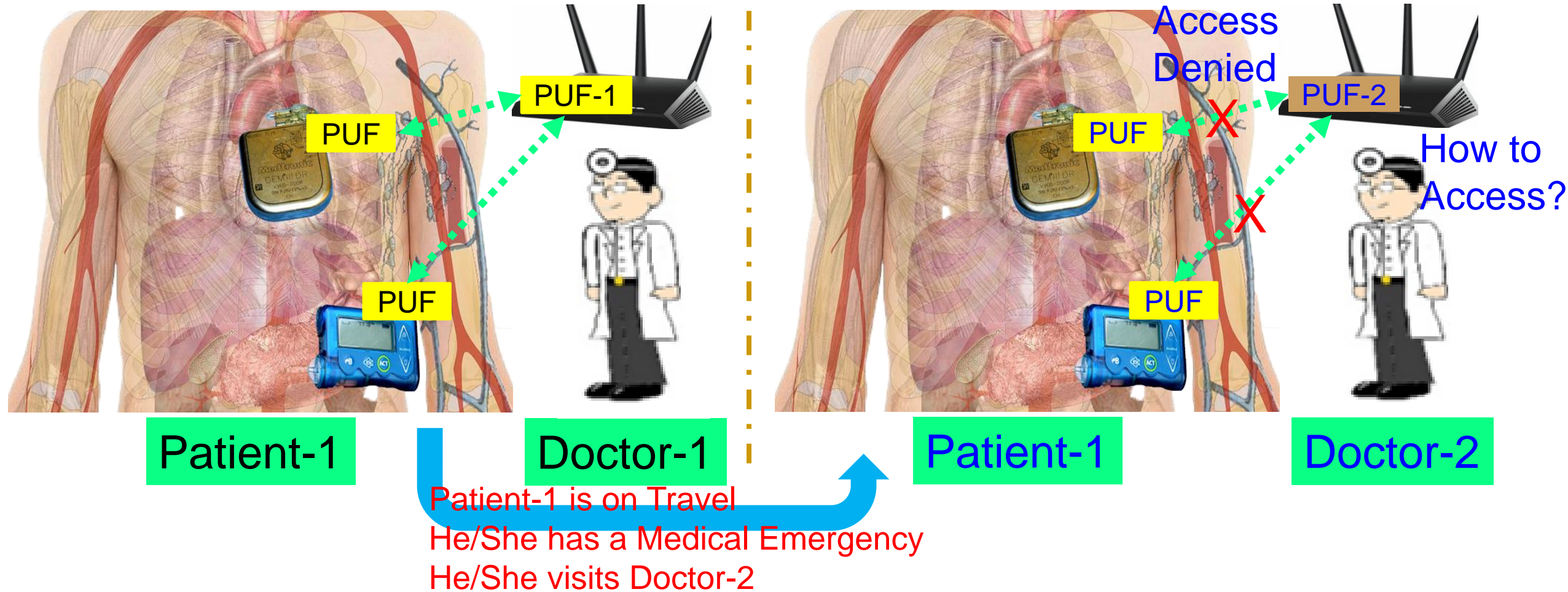

---

# Is Blockchain the Solution for Every Cybersecurity Problem?



# Blockchain has Many Challenges

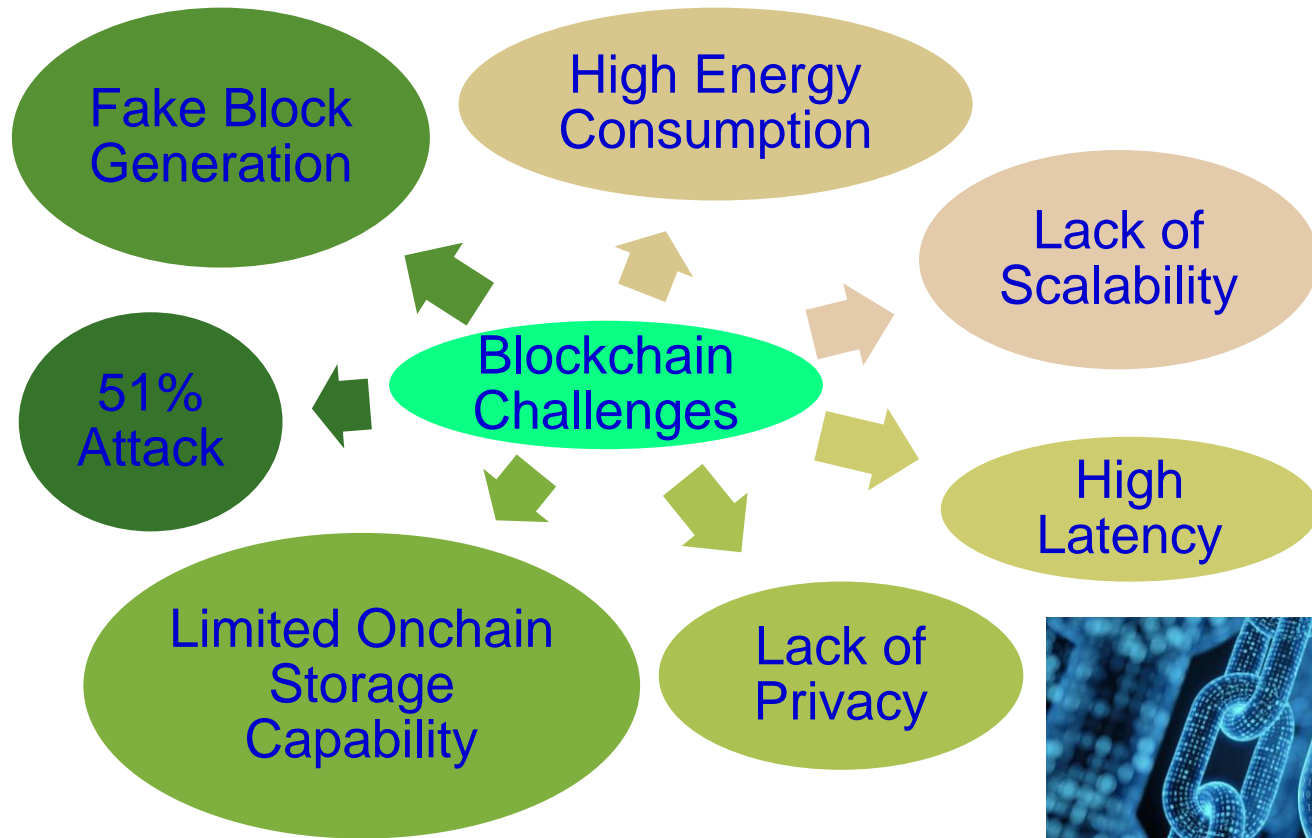

Source: <https://www.etorox.com>



Source: <https://www.monash.edu/blockchain/news/how-do-we-know-blockchain-cant-be-hacked-or-manipulated-or-can-it>

Source: D. Puthal, N. Malik, S. P. Mohanty, E. Kougianos, and G. Das, "Everything you Wanted to Know about the Blockchain", *IEEE Consumer Electronics Magazine*, Volume 7, Issue 4, July 2018, pp. 06--14.

# Blockchain Energy Need is Huge



Energy for mining of 1 bitcoin



Energy consumption 2 years of a US household



Energy consumption for each bitcoin transaction



80,000 X

Energy consumption of a credit card processing



# Blockchain has Cybersecurity Challenges

## Selected attacks on the blockchain and defences

Attacks	Descriptions	Defence
Double spending	Many payments are made with a body of funds	Complexity of mining process
Record hacking	Blocks are modified, and fraudulent transactions are inserted	Distributed consensus
51% attack	A miner with more than half of the network's computational power dominates the verification process	Detection methods and design of incentives
Identity theft	An entity's private key is stolen	Reputation of the blockchain on identities
System hacking	The software systems that implement a blockchain are compromised	Advanced intrusion detection systems

Source: N. Kolokotronis, K. Limniotis, S. Shiaeles, and R. Griffiths, "Secured by Blockchain: Safeguarding Internet of Things Devices," *IEEE Consumer Electronics Magazine*, vol. 8, no. 3, pp. 28–34, May 2019.



# When do You Need the Blockchain?

Information of the System that may need a blockchain?

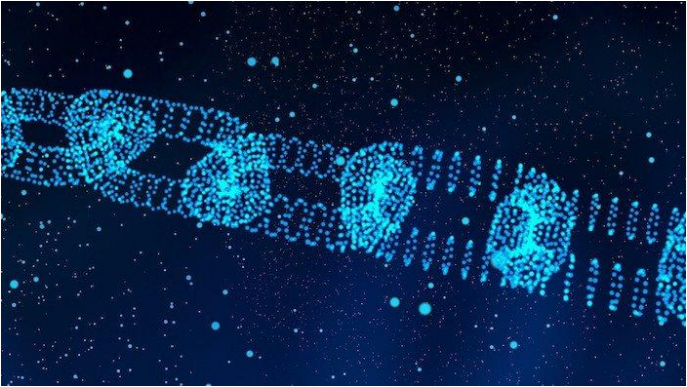
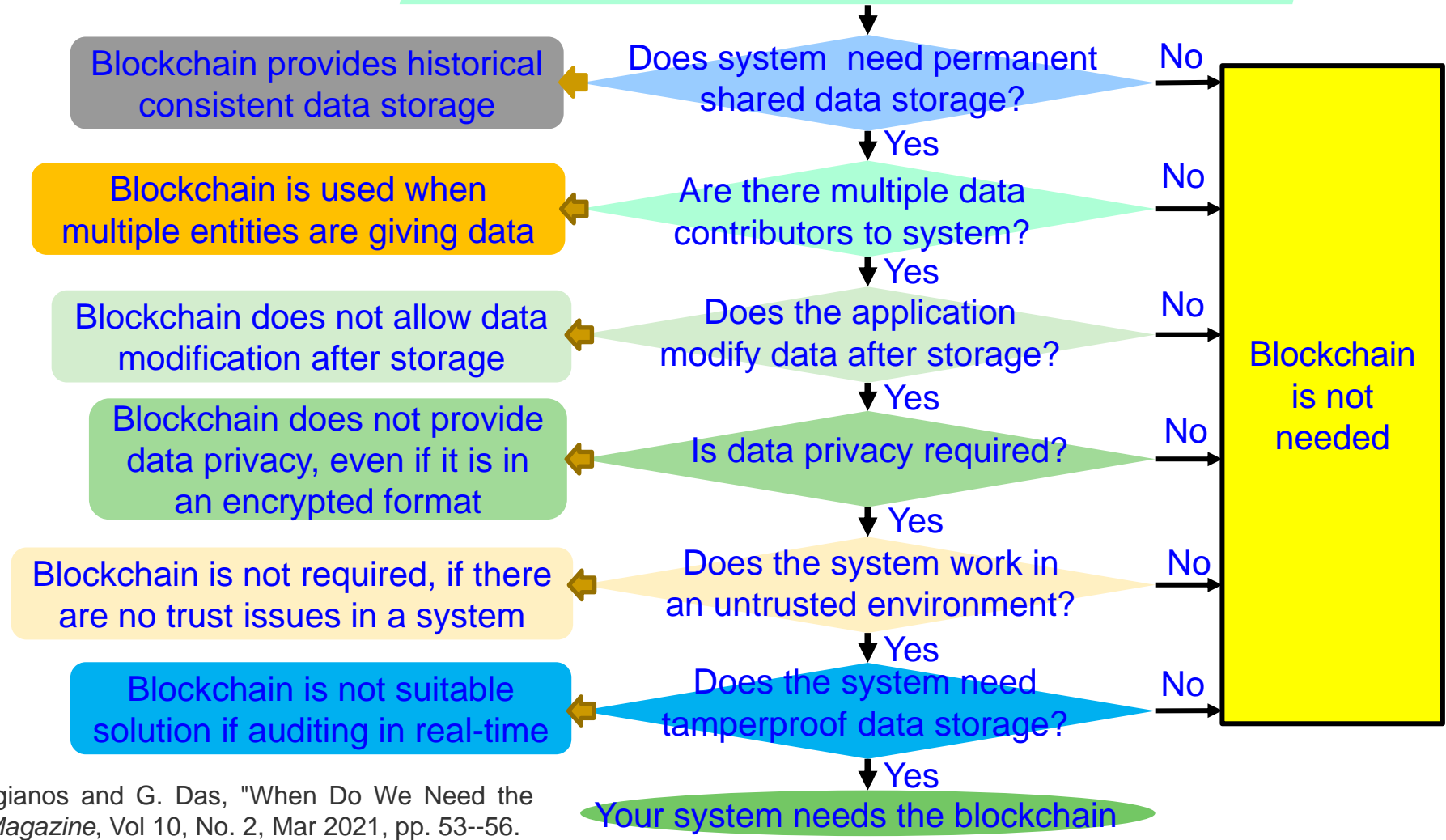

Source: D. Puthal, S. P. Mohanty, E. Kougianos and G. Das, "When Do We Need the Blockchain?," *IEEE Consumer Electronics Magazine*, Vol 10, No. 2, Mar 2021, pp. 53--56.



---

# Conclusions and Future Research



---

# Conclusions

- Healthcare has been evolving to Healthcare-CPS (H-CPS).
- Internet of Medical Things (IoMT) is key for smart healthcare.
- Smart healthcare can reduce cost of healthcare and give more personalized experience to the individual.
- IoMT provides advantages but also has limitations in terms of security, and privacy.
- Cybersecurity in smart healthcare is challenging as device as well as data security and privacy are important.
- Medical device security is a difficult problem as these are resource and battery constrained.
- Security-by-Design and/or Privacy-by-Design is critical for IoMT/H-CPS.

---

# Future Research

- ML models for smart healthcare needs research.
- Internet-of-Everything (IoE) with Human as active part need research.
- IoE will need robust data, device, and H-CPS security need more research.
- Security of IWMDs needs to have extremely minimal energy overhead to be useful and hence needs research.
- Integration of blockchain for smart healthcare need research due to energy and computational overheads associated with it.
- SbD research for IoMT/H-CPS is needed.
- PbD research for IoMT/H-CPS is needed.
- Trustworthy Pharmaceutical Supply Chain needs research.